

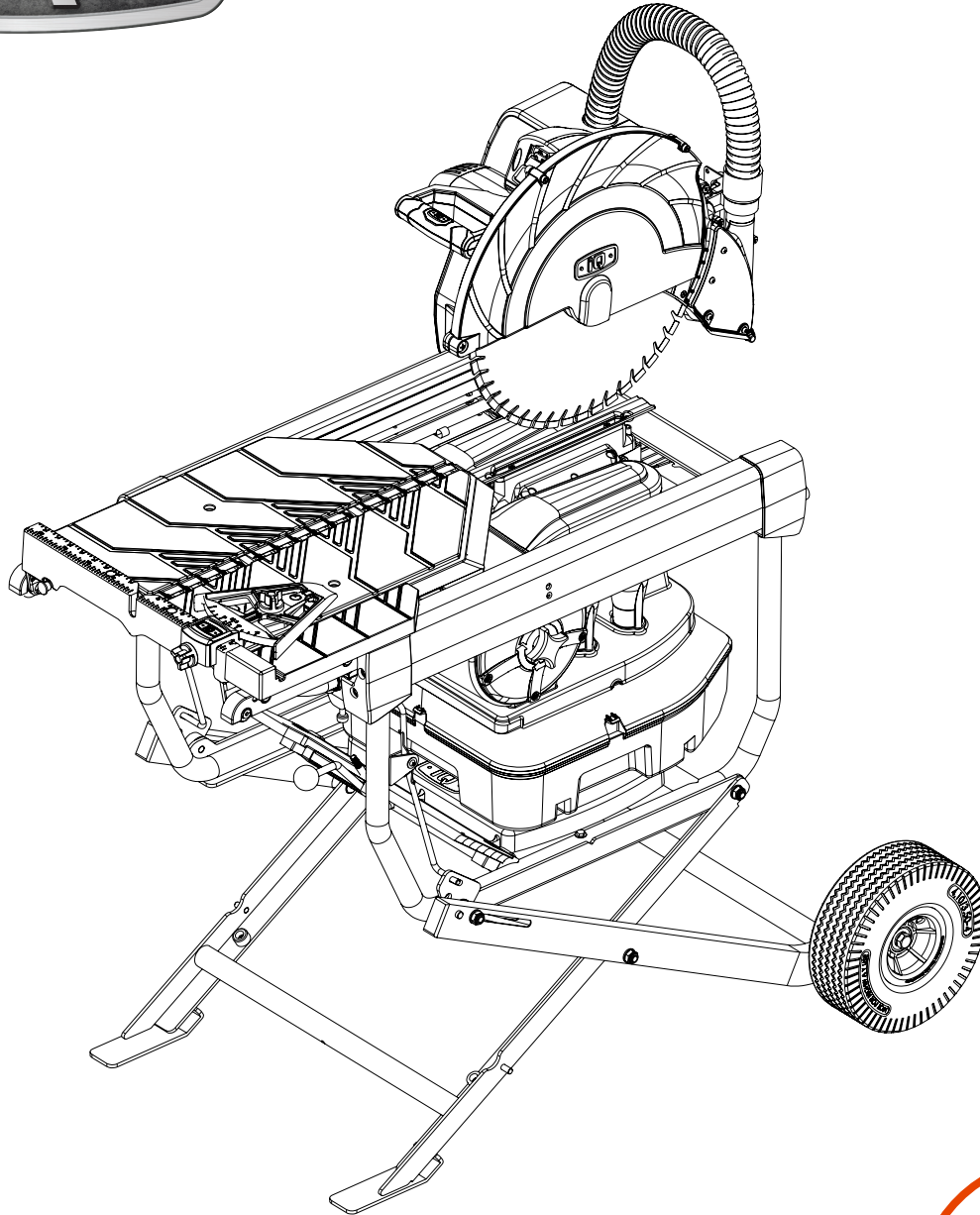

POWER TOOLS™



iQMS362 16.5" Masonry Saw



Operator's Manual

Use QR Code to download the iQMS362 Operator's Manual in your language. Please read the operator's manual carefully and make sure you understand the instructions before using the machine.

Utilisez le code QR pour télécharger le manuel d'utilisation de l'iQMS362 dans votre langue.

Utilizzare il codice QR per scaricare il manuale dell'operatore iQMS362 nella propria lingua

Gebruik de QR-code om de iQMS362 bedieningshandleiding in uw taal te downloaden

Brug QR-kode til at downloade brugervejledningen til iQMS362 på dit sprog

Verwenden Sie den QR-Code, um das iQMS362-Benutzerhandbuch in Ihrer Sprache herunterzuladen

TABLE OF CONTENTS

Topic	Section
Key Symbols	1
Explanation Of Warning Levels	1.1
Symbols on the Machine	1.1
Safety Rules	2
Introduction	3
Design And Features	3.1
iQMS362	3.1
What Is What?	4
Machine's Safety Equipment	5
Safety	6
Personal Protective Equipment	6.1
Personal Safety	6.2
Machine Care	6.2
General Safety Precautions	6.3
Electrical Safety	6.3
Assembling	7
Mounting The X-Stand	7.2
Installing The Wheels	7.2
Mounting The Support Arm	7.3
Attaching Dust Guard Vacuum Hose	7.3
Connecting The Vacuum Motor Power	7.4
Installing The Transport Handle	7.4
Assembling The Table Extension	7.5
Installing The Rolling Table	7.5
Blades	8
Blade Installation	8.2
Operating	9
Before You Start	9.1
Basic Working Techniques	9.1
General Maintenance	9.2
Vacuum And Filter Maintenance	10
Cleaning The Filter and Emptying Dust Tray	10.1
Changing The Filter	10.2
Replacing The Carbon Brushes	10.3
Changing The Louvers	10.4
Adjustments	11
Adjusting The Top Slot	11.1
Adjusting The Rolling Table Upper Rollers	11.1
Adjusting And Squaring The Rolling Table	11.2
X-Stand	12
Transporting	13
Storage	13.1
Troubleshooting	14
Technical Data	15
Wiring Diagram	16
Warranty Policy	17

KEY SYMBOLS & SAFETY RULES

Explanation of Warning Levels

The warnings are graded in three levels.

⚠ WARNING

Used if there is a risk of serious injury or death for the operator or damage to the surroundings if the instructions in the manual are not followed.

⚠ CAUTION

Used if there is a risk of injury to the operator or damage to the surroundings if the instructions in the manual are not followed.

⚠ NOTICE

Used if there is a risk of damage to materials or the machine if the instructions in the manual are not followed.



Please read the operator's manual carefully and make sure you understand the instructions before using the machine or performing any maintenance.



Always wear hearing protection.



Always wear protective goggles and/or a visor.

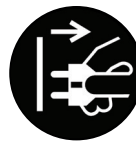

High voltage. Risk of an electric shock. Turn off machine and unplug before transportation.



Should not be disposed of with general household waste, but collected separately for reuse or recycling.



Keep your hands and feet away from the blade.



CSA approved.

Symbols on the machine



WARNING! The machine can be a dangerous tool if used incorrectly or carelessly, which can cause serious or fatal injury to the operator or others.



iqms362-CSA
16.5" MASONRY SAW
Q-DRIVE ARBOR
120V- 60Hz 20A 3700RPM

WARNING: FOR YOUR SAFETY



IQPOWERTOOLS.COM • 888-274-7744
PO Box 7449 Moreno Valley, CA
2017 • Made in Taiwan

KEY SYMBOLS & SAFETY RULES

Other symbols/decals on the machine refer to special certification requirements for certain markets.

DUST COLLECTION VACUUM OPERATION



1. Spin filter every 30 minutes of cutting or at the end of each day. Spin filter before emptying dust collection tray.
2. Empty dust collection tray after approx. 150 L.F of cutting or at the end of each day before transport.
3. Empty dust into bag or sealed container and dispose properly.

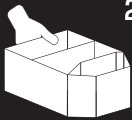

Additional Safety Warnings



Do not expose to rain.



Never cut without using the blade guard.



Risk of injury due to accidental starting. Do not use in an area where children may be present.



Unused masonry saw may cause personal injury - Remove this masonry saw blade when using other accessories.



Always use manufacturer's approved cutting wheels.

TRANSPORT INSTRUCTIONS

1. Turn machine OFF.
Unplug and secure power cord.
2. Lock cutting head in a down position.
3. Lock rolling table before transport.
4. Unlock transport handle and extend for easy transport.

SAFETY RULES

Safety Rules

1. KEEP GUARDS IN PLACE and in working order.

2. REMOVE ADJUSTING KEYS AND WRENCHES. Form habit of checking to see that keys and adjusting wrenches are removed from tool before turning it on.

3. KEEP WORK AREA CLEAN. Cluttered areas and benches invite accidents.

4. DON'T USE IN DANGEROUS ENVIRONMENT. Don't use power tools in damp or wet locations, or expose them to rain. Keep work area well lighted.

5. KEEP CHILDREN AWAY. All visitors should be kept at a safe distance from work area.

6. MAKE WORKSHOP CHILD PROOF with padlocks, master switches, or by removing starter keys.

7. DON'T FORCE TOOL. It will do the job better and safer at the rate for which it was designed.

8. USE RIGHT TOOL. Don't force tool or attachment to do a job for which it was not designed.

9. USE PROPER EXTENSION CORD. Make sure your extension cord is in good condition. When using an extension cord, be sure to use one heavy enough to carry the current your product will draw. An undersized cord will cause a drop in line voltage resulting in loss of power and overheating. Refer to electrical safety section for proper extension cord selection.

10. WEAR PROPER APPAREL. Do not wear loose clothing, gloves, neck ties, rings, bracelets, or other jewelry which may get caught in moving parts. Non-slip footwear is recommended. Wear protective hair covering to contain long hair.

11. ALWAYS USE SAFETY GLASSES. Also use face or dust mask if cutting operation is dusty. Everyday eyeglasses only have impact resistant lenses, they are NOT safety glasses.

12. DON'T OVERREACH. Keep proper footing and balance at all times.

13. MAINTAIN TOOLS WITH CARE. Keep tools sharp and clean for best and safest performance. Follow instructions for lubricating and changing accessories.

14. DISCONNECT TOOLS before servicing; when changing accessories such as blades, bits, cutters, etc.

15. REDUCE THE RISK OF UNINTENTIONAL STARTING. Make sure switch is in off position before plugging in.

16. USE RECOMMENDED ACCESSORIES. Consult the owner's manual for recommended accessories. The use of improper accessories may cause risk of injury to persons.

17. NEVER STAND ON TOOL. Serious injury could occur if the tool is tipped or if the cutting tool is unintentionally contacted.

18. CHECK DAMAGED PARTS. Before further use of the tool, a guard or other part that is damaged should be carefully checked to determine that it will operate properly and perform its intended function - check for alignment of moving parts, binding of moving parts, breakage of parts, mounting, and any other conditions that may affect its operation. A guard or other part that is damaged should be properly repaired or replaced.

19. DIRECTION OF FEED. Feed work into a blade or cutter against the direction of rotation of the blade or cutter only.

20. NEVER LEAVE TOOL RUNNING UNATTENDED TURN POWER OFF. Don't leave tool until it comes to a complete stop.

INTRODUCTION

Dear Customer

We at IQ Power Tools™ want to congratulate you on selecting the iQMS362™ Dust Control Masonry Saw. We are certain that you will be pleased with your purchase. IQ Power Tools takes pride in manufacturing the most innovative tools and equipment in the industry.

If operated correctly, your iQMS362™ should provide you with years of quality service. This operator's manual contains information you need to operate and maintain your iQMS362™ safely and correctly. Please take a few minutes to familiarize yourself with your new iQMS362™ by reading and reviewing this manual.

If you should have any questions concerning your iQMS362™ please feel free to contact us at
Phone: (888) 274-7744
Email: customer.service@iqpowertools.com

It is our wish that you will be satisfied with your product and that it will prove to be a valued tool for a long time. A purchase of one of our products gives you access to professional help with repairs and services. If the retailer who sells your machine is not one of our authorized dealers, ask him for the address of your nearest service workshop.

This operator's manual is a valuable document. Make sure it is always at hand at the work place. By following its content (using, service, maintenance etc.) the life span and the second-hand value of the machine can be extended. If you ever lend or sell this machine, make sure that the borrower or buyer gets the operator's manual so they will also know how to properly maintain and use it.

Owner Responsibility

It is the owner's/employer's responsibility to ensure that the operator has sufficient knowledge about how to use the machine safely. Supervisors and operators must have read and understood the Operator's Manual. They must be aware of:

- The machine's safety instructions.
- The machine's range of applications and limitations.
- How the machine is to be used and maintained.

Local regulations could restrict the use of this machine. Find out what regulations are applicable where you work before you start using the machine.

The Manufacturer's Reservation

Subsequent to publishing this manual IQ Power Tools may issue additional information for safe operation of this product. It is the owner's obligation to keep up with the safest methods of operation.

iQ Power Tools has a policy of continuous product development and therefore reserves the right to modify the design and appearance of products without prior notice.

For customer information and assistance, contact us at our website: www.iQPowerTools.com

Design & Features

Values such as high performance, reliability, innovative technology, and environmental considerations distinguish iQ Power Tools' products. Safe operation of this product requires the operator to read this manual carefully. Ask your dealer or iQ Power Tools should you need more information.

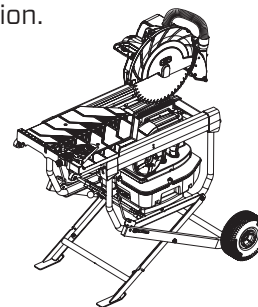

iQMS362™

DESIGNED WITH AN INTEGRATED VACUUM SYSTEM, FILTER SYSTEM AND DUST CONTAINMENT

This innovative patent pending design combines the features of a professional saw with a powerful cyclonic vacuum system that cuts cleanly and efficiently with no water and no dust.

COMPACT AND MOBILE DESIGN

With compact size and built-in wheels the integrated pull out handle makes for easy transport.

LARGE CUT CAPACITY

Enables cutting of 24"x24" (600mm x 600mm) and 18" on diagonal depending on thickness.

FUNCTIONAL ROLLING TABLE WITH EXPANDABLE TABLE EXTENSION

The rolling table is extra long for better support when cutting. The table extension can be extended for larger materials, then collapsed in for easy transport.

WHAT IS WHAT?

Front-side

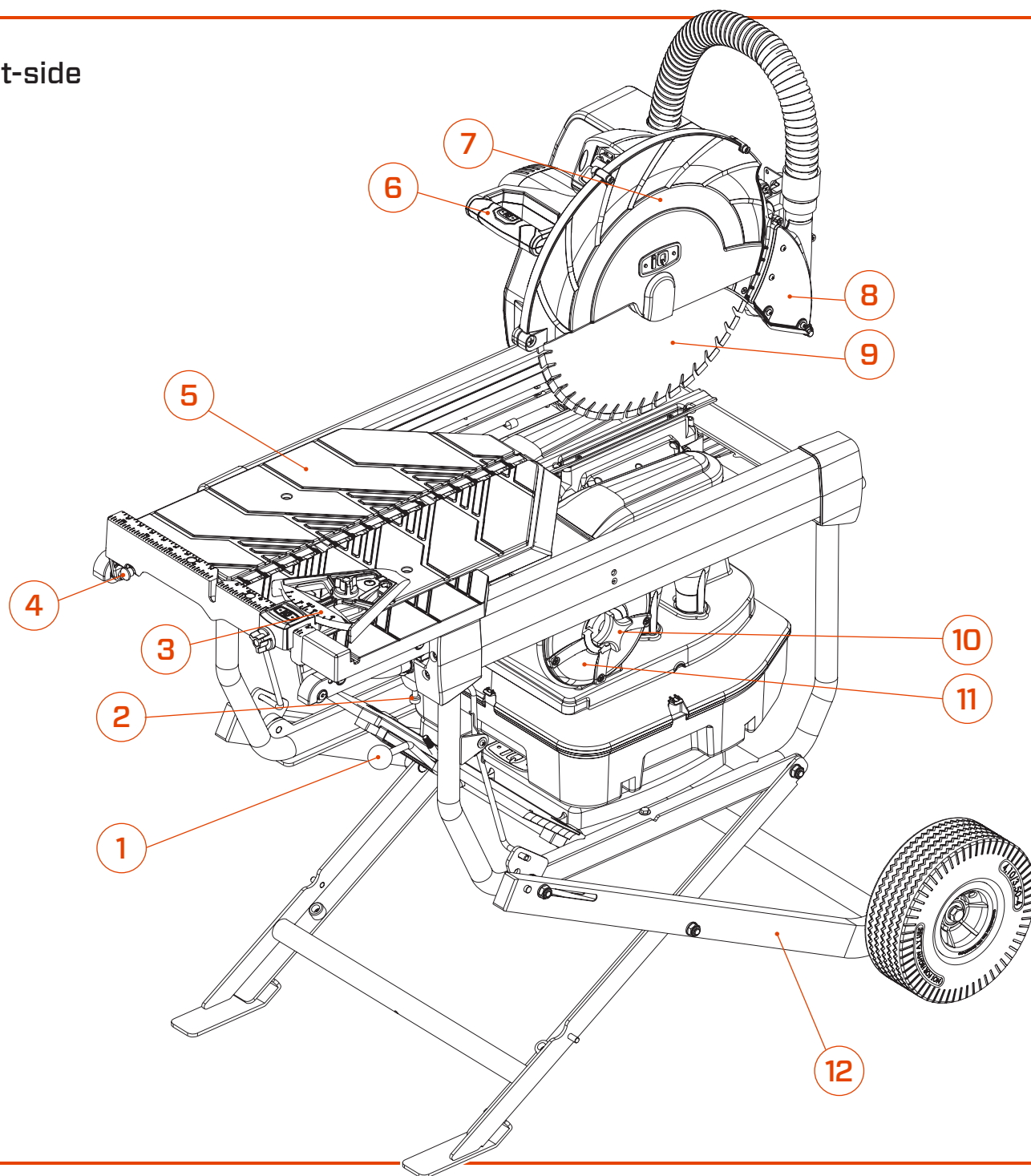

1 - Dust Tray Lift Lever

2 - Transport Handle Lock

3 - Cutting Guide

4 - Rolling Table Lock Knob

5 - Rolling Table

6 - Handle

7 - Blade Guard

8 - Dust Guard

9 - Blade

10 - Filter Spin Knob

11 - Filter Cover

12 - X-Stand

WHAT IS WHAT?

Backside

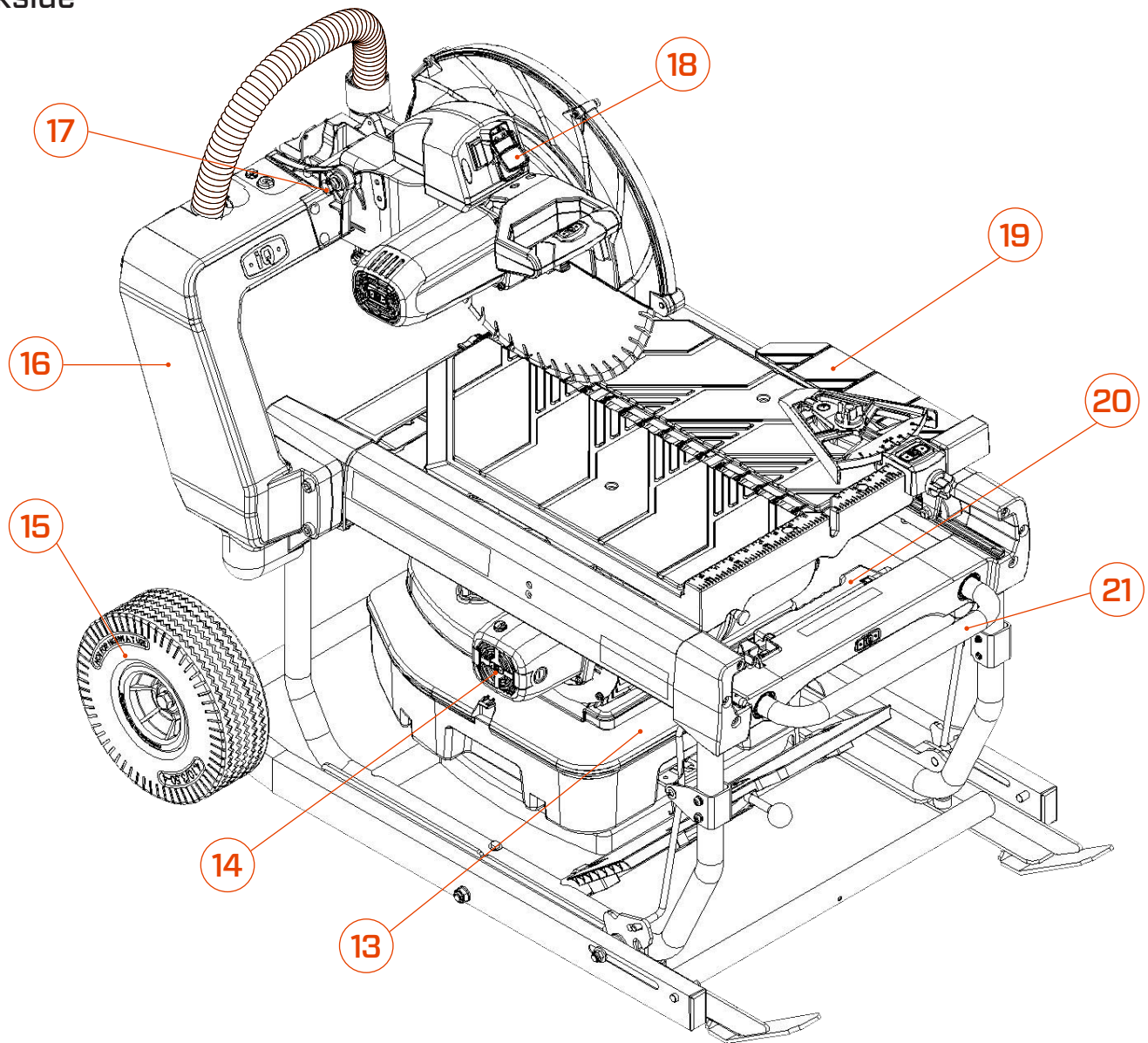

13 - Dust Tray

14 - Vacuum Motor

15 - Wheels

16 - Support Arm

17 - Lock Down Knob

18 - Power Switch

19 - Extension Table

20 - X-Stand Lock Release Trigger

21 - Transport Handle

WHAT IS WHAT?

Front

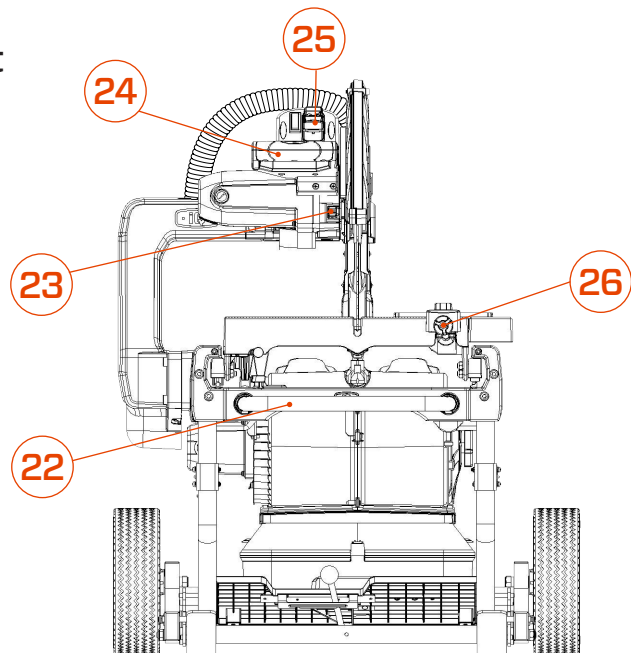

Back

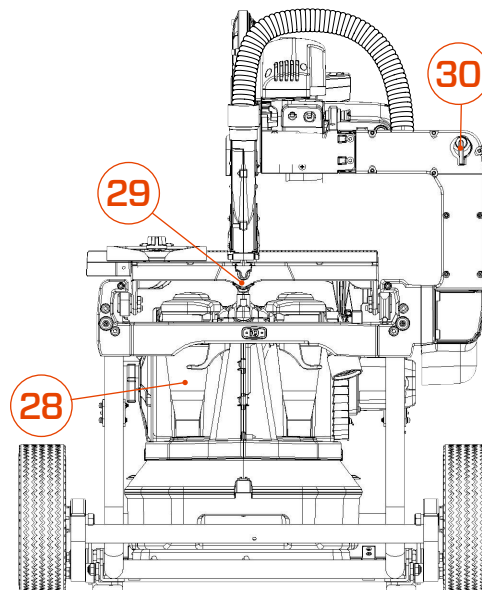

Top

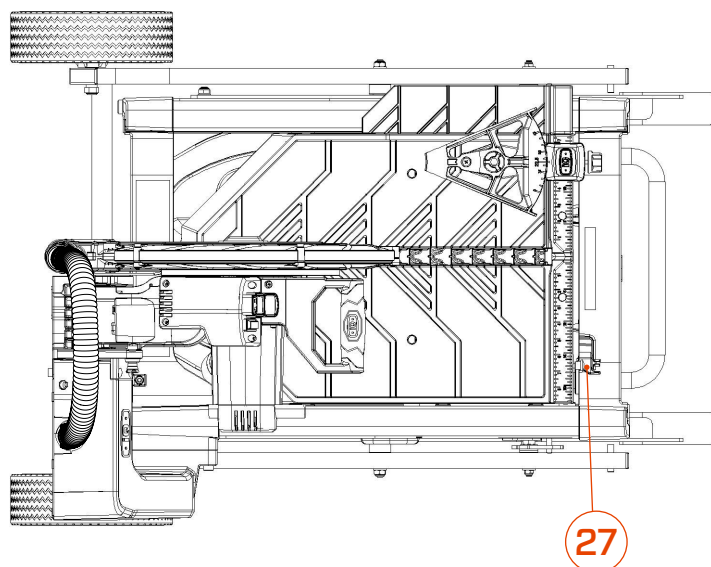

22 - Transport Handle

23 - Blade Lock Button

24 - Handle

25 - Power Switch

26 - Extension Table Lock Knob

27 - Table Remove Lever

28 - Cyclones

29 - Top Slot

30 - Blade/Assembly Wrench

MACHINE'S SAFETY EQUIPMENT

General

This section describes the machine's safety equipment, its purpose, and how checks and maintenance should be carried out to ensure that it operates correctly.

⚠ WARNING! NEVER USE A MACHINE THAT HAS FAULTY SAFETY EQUIPMENT

BLADE GUARD

⚠ WARNING! NEVER USE THE MACHINE WITHOUT A GUARD NOR WITH A DEFECTIVE GUARD. ALWAYS CHECK THAT THE GUARD IS CORRECTLY FITTED BEFORE STARTING THE MACHINE.

IT IS NOT PERMITTED TO EXPOSE THE BLADE MORE THAN 180 DEGREES WITHOUT PROTECTION.

The blade guard is designed to prevent parts of the blade or cutting fragments from being thrown towards the user.

CHECKING THE BLADE GUARD

Check that the guard over the blade is not cracked or damaged in any other way. Replace when damaged.

⚠ WARNING! SHUT DOWN THE MACHINE AND DISCONNECT THE POWER PLUG.

DUST GUARD

The dust guard is designed to prevent dust being pulled up from the backside of the blade. The dust guard should be inspected periodically for damage. The dust guard should move freely sliding up and over cutting material.

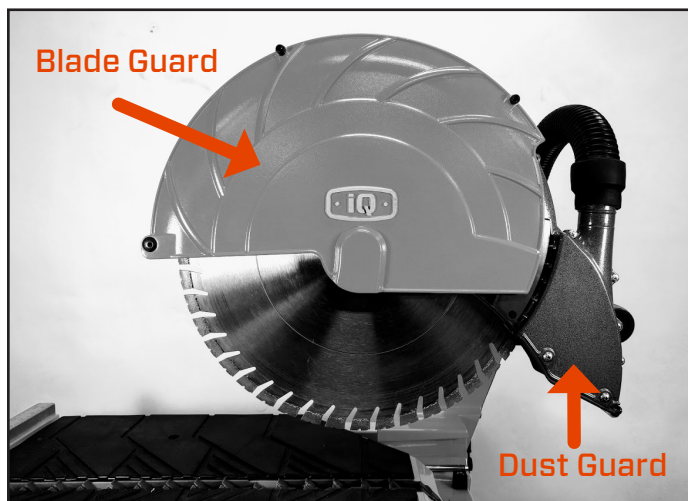

SAW POWER SWITCH

The power switch - / 0 should be used to start and stop the machine.

CHECKING THE SAW POWER SWITCH

The saw power switch starts the saw motor and vacuum motor simultaneously.

To start the saw motor pull the **POWER** switch. To stop the saw motor press the **POWER** switch.

Defective switches should be replaced by an authorized service workshop.

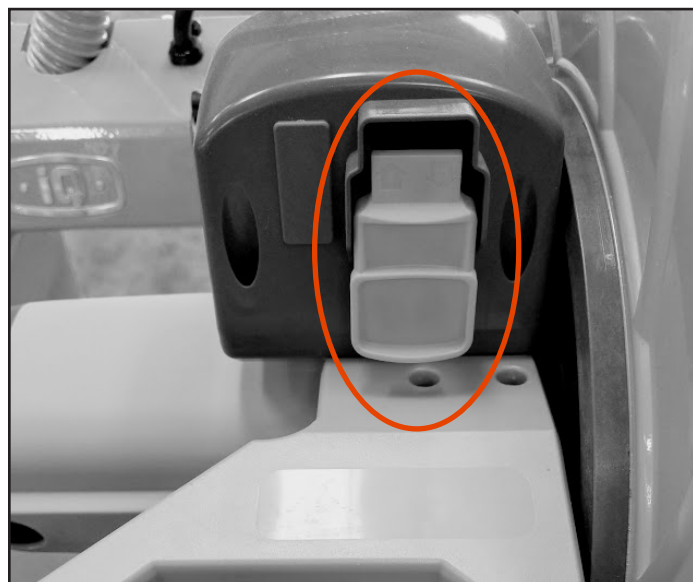

LOCKING KNOB, ROLLING TABLE

The locking knob is used to lock the rolling table in place when in transit. Be sure to lock rolling table before transit to avoid injury.

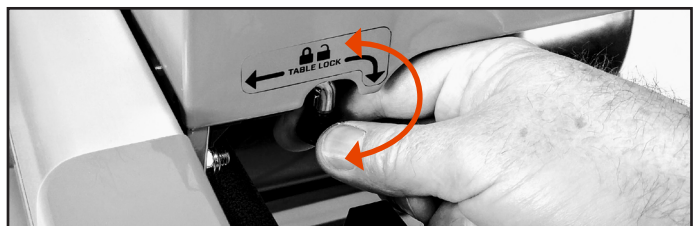

SAFETY

General

Do not use the machine unless you are able to call for help in the event of an accident. Always have a first aid kit nearby.

⚠ WARNING! POWER TOOLS AND CUTTING MACHINES HAVE THE POTENTIAL TO CREATE SPARKS. ALWAYS KEEP FIRE EXTINGUISHERS HANDY.

⚠ WARNING! SAWING, DRILLING AND GRINDING GENERATES DUST THAT COMES FROM THE MATERIAL BEING CUT, WHICH FREQUENTLY CONTAINS SILICA. SILICA IS A BASIC COMPONENT OF SAND, QUARTZ, BRICK CLAY, GRANITE AND NUMEROUS OTHER MINERALS AND ROCKS.

ALWAYS EMPLOY ENGINEERED DUST CONTROLS AND PERSONAL PROTECTION EQUIPMENT SUITABLE TO THE MATERIAL BEING SAWED, DRILLED OR GROUND; SEE OSHA (29 CFR PART 1910.1200).

NEVER EXPOSE YOURSELF OR BYSTANDARDS TO HAZARDOUS DUST THAT EXCEEDS THE PERMISSIBLE EXPOSURE LIMIT (PEL) AS SET BY YOUR LOCAL JURISDICTION OR GOVERNING AGENCY. E.G. OSHA, CSST.

⚠ WARNING! THE USE OF PRODUCTS SUCH AS CUTTERS, GRINDERS, DRILLS THAT SAND OR FORM MATERIAL CAN GENERATE DUST AND VAPORS WHICH MAY CONTAIN HAZARDOUS CHEMICALS. CHECK THE NATURE OF THE MATERIAL YOU INTEND TO PROCESS AND USE AN APPROPRIATE BREATHING MASK.

⚠ WARNING! USE OF THIS PRODUCT CAN CAUSE EXPOSURE TO MATERIALS KNOWN TO THE STATE OF CALIFORNIA TO CAUSE CANCER AND/OR BIRTH DEFECTS OR OTHER REPRODUCTIVE HARM.

⚠ WARNING! PROTECT YOURSELF AND OTHERS FROM OVEREXPOSURE. REFER TO YOUR LOCAL JURISDICTION OR GOVERNING AGENCY. E.G. OSHA, CSST.

PERSONAL PROTECTIVE EQUIPMENT

You must use approved personal protective equipment whenever you use the machine. Personal protective equipment cannot eliminate the risk of injury but it will reduce the degree of injury if an accident does happen.

Listen out for warning signals or shouts when you are wearing hearing protection. Always remove your hearing protection as soon as the motor stops.

Always use approved eye protection

- If you use a face shield then you must also wear approved protective goggles. Approved protective goggles must comply with standard ANSI Z87.1 in the USA or EN 166 in EU countries. Visors must comply with standard EN 1731.

Recommended Personal Protective Equipment:

- Hearing protection
- Breathing mask
- Protective gloves.
- Hair covering or devices to contain long hair, i.e.: Hair Ties For Guys

⚠ CAUTION! LONG TERM EXPOSURE TO NOISE CAN RESULT IN PERMANENT HEARING IMPAIRMENT. ALWAYS USE APPROVED HEARING PROTECTION.

⚠ WARNING! THERE IS ALWAYS A RISK OF CRUSH INJURIES WHEN WORKING WITH PRODUCTS CONTAINING MOVING PARTS. WEAR PROTECTIVE GLOVES TO AVOID BODY INJURIES.

Generally, clothes should be close-fitting without restricting your freedom of movement. Be careful as clothing, long hair, and jewelry can get caught in moving parts.

SAFETY

WORK AREA SAFETY

- Keep work area clean and well lit. Cluttered or dark areas invite accidents.
- People and animals can distract you causing you to lose control of the machine. For this reason, always remain concentrated and focused on the task.
- Do not use the machine in bad weather such as dense fog, heavy rain, strong wind, intense cold, etc.
- Never start to work with the machine before the working area is clear and you have a stable work surface.

PERSONAL SAFETY

Never use the machine if you are fatigued, while under the influence of alcohol or drugs, medication or anything that could affect your vision, alertness, coordination or judgement.

- Check that no tools or other objects have been left lying on the machine.
- Never allow anyone else to use the machine without proper training.
- Always shut off the machine during remove work breaks.
- Never work alone, always ensure there is another person close at hand.
- Learn how to use the machine and its controls safely and learn to how to stop quickly. Also learn to recognize the safety decals.
- Keep handles dry, clean and free from oil and grease.
- Do not overreach. Keep proper footing and balance at all times.
- Never stand on the machine.

MACHINE USE AND CARE

- This machine is designed and intended for cutting tile, masonry, concrete and stone products. All other use is improper.
- Experience is very important when running the machine. A skilled worker is highly recommended.
- The machine is intended for use in industrial applications by experienced operators.
- Check that the machine is assembled correctly and does not show any signs of damage.
- Always perform daily maintenance before starting the machine. See instructions in the

section “Maintenance”.

- Do not overload the machine. Overloading can damage the machine.
- The blade shall be intended for the material to be cut.
- If you are uncertain of what blade to use contact your local service dealer.
- Keep tools sharp and clean in order to enable safer work.
- Keep all parts in good working order and ensure that all fixtures are properly tightened. Replace all worn or damaged decals.
- Never leave the machine unsupervised with the motor running.
- Feed the work piece against the rotation of the blade only!
- Observe care when lifting. You are handling heavy parts, which imply the risk of pinch injuries or other injuries.
- Maximum rolling table material weight capacity is 40LBS/20KG.



Stand upright. Keep distance between your face and the cutting blade. Place both hands on the work piece as far away from the cutting blade as possible. If plunge function is used, place one hand on the cutting handle.

SAFETY

GENERAL SAFETY PRECAUTIONS

This section describes basic safety directions for using the machine. This information is never a substitute for professional skills and experience.

- Please read the operator's manual carefully and make sure you understand the instructions before using the machine. Save all warnings and instructions for future reference.
- Keep in mind that the operator is responsible for accidents or hazards occurring to other people or their property.
- All operators shall be trained in the use of the machine.

The owner is responsible for ensuring that the operators receive training.

- The machine must be kept clean. Signs and stickers must be fully legible.

⚠ WARNING! THE MACHINE CAN BE A DANGEROUS TOOL IF USED INCORRECTLY OR CARELESSLY, WHICH CAN CAUSE SERIOUS OR FATAL INJURY TO THE OPERATOR OR OTHERS.

- Never allow children or other persons not trained in the use of the machine to use or service it.
- Never allow anyone else to use the machine without first ensuring that they have read and understood the contents of the operator's manual.
- Never use the machine if you are fatigued, while under the influence of alcohol or drugs, medication or anything that could affect your vision, alertness, coordination or judgement.

⚠ WARNING! UNAUTHORIZED MODIFICATIONS AND/ OR ACCESSORIES MAY LEAD TO SERIOUS INJURY OR DEATH TO THE USER OR OTHERS.

Do not modify this product or use it if it appears to have been modified by others.

Never use a machine that is faulty. Carry out the safety checks, maintenance and service instructions described in this manual. Some maintenance and service measures must be carried out by trained and qualified specialists. See instructions under the heading Maintenance. Always use genuine accessories. Contact your dealer for more information.

ALWAYS THINK ABOUT YOUR WORK ENVIRONMENT AND USE COMMON SENSE.

It is not possible to cover every conceivable situation you can face. Always exercise care and use your common sense. If you get into a situation where you feel unsafe, stop and seek expert advice. Contact your dealer, service agent or an experienced user. Do not attempt any task or operation that makes you feel unsure whether or not it is safe.

ELECTRICAL SAFETY

WARNING! There is always a risk of shocks from electrically powered machines. Avoid unfavourable weather conditions and bodily contact with lightning conductors and metal objects. Always follow the instructions in the Operator's manual to avoid damage.

⚠ WARNING! WHEN CLEANING THE MACHINE MAKE SURE TO AVOID WATER ENTERING THE ELECTRICAL SYSTEM AND THE MOTOR UNIT. WATER CAN CAUSE DAMAGE TO THE MACHINE OR SHORT CIRCUIT.

- Never connect the machine to an outlet if plug or cord is damaged.
- Check that the main voltage corresponds with that stated on the rating plate on the machine.
- Inspection and/or maintenance should be carried out with the motor switched off and the plug disconnected.
- Always shut down the machine before disconnecting the power plug.
- Never drag the machine by means of the cord and never pull out the plug by pulling the cord. Hold the plug to disconnect the power cord.
- Never use the machine if any cable or plug is damaged, but hand it in to an authorized service workshop for repair.
- Prevent unintentional starting of the motor. Ensure the power switch is in the **OFF**-position before connecting the machine to a power source.
- Do not modify the plug. If it will not fit the outlet, have a proper outlet installed by a qualified electrician. Make sure local regulations and ordinances are followed.

SAFETY

⚠ WARNING! IMPROPER CONNECTION CAN RESULT IN THE RISK OF ELECTRIC SHOCK. CONTACT A QUALIFIED ELECTRICIAN IF IN DOUBT AS TO WHETHER THE APPLIANCE IS PROPERLY GROUNDED.

20 AMP POWER REQUIRED

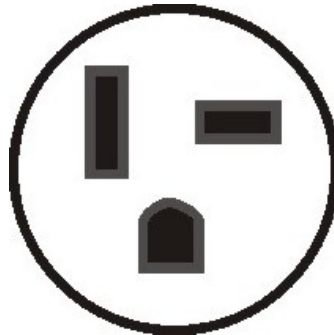

EXTENSION CORDS AND CABLES

The marking on the extension cable must be the same or higher than the value stated on the machine's rating plate.

- When operating a power tool outdoors, use an extension cord suitable for outdoor use. Use of a cord suitable for outdoor use reduces the risk of electric shock.
- Keep the connection to the extension cord dry and off the ground.
- Keep cable away from heat, oil, sharp edges or moving parts. Damaged or entangled cables increase the risk of electric shock.
- Check that the cord and extension cord are intact and in good condition. Never use the machine if any cable or plug is damaged. Take it into an authorized service workshop for repair.
- To avoid overheating, do not use the extension cord while it is rolled up.
- When using an extension cable, use only certified extension cables with sufficient reach.

RECOMMENDED CABLE DIMENSIONS

25FT	50FT	100FT	150FT
AWG	AWG	AWG	AWG
12	10	NOT RECOMMENDED	NOT RECOMMENDED
VOLTS 120v	VOLTS 120v	VOLTS 120v	VOLTS 120v

⚠ NOTICE! GOOD MOTOR PERFORMANCE DEPENDS ON PROPER VOLTAGE. EXTENSION CABLES THAT ARE TOO LONG AND/OR HAVE A GAUGE THAT IS TOO SMALL, REDUCE POWER TO THE MOTOR UNDER LOAD, RESULTING IN REDUCED OUTPUT OR MALFUNCTIONS.

ASSEMBLING

TOOLS REQUIRED FOR ASSEMBLY

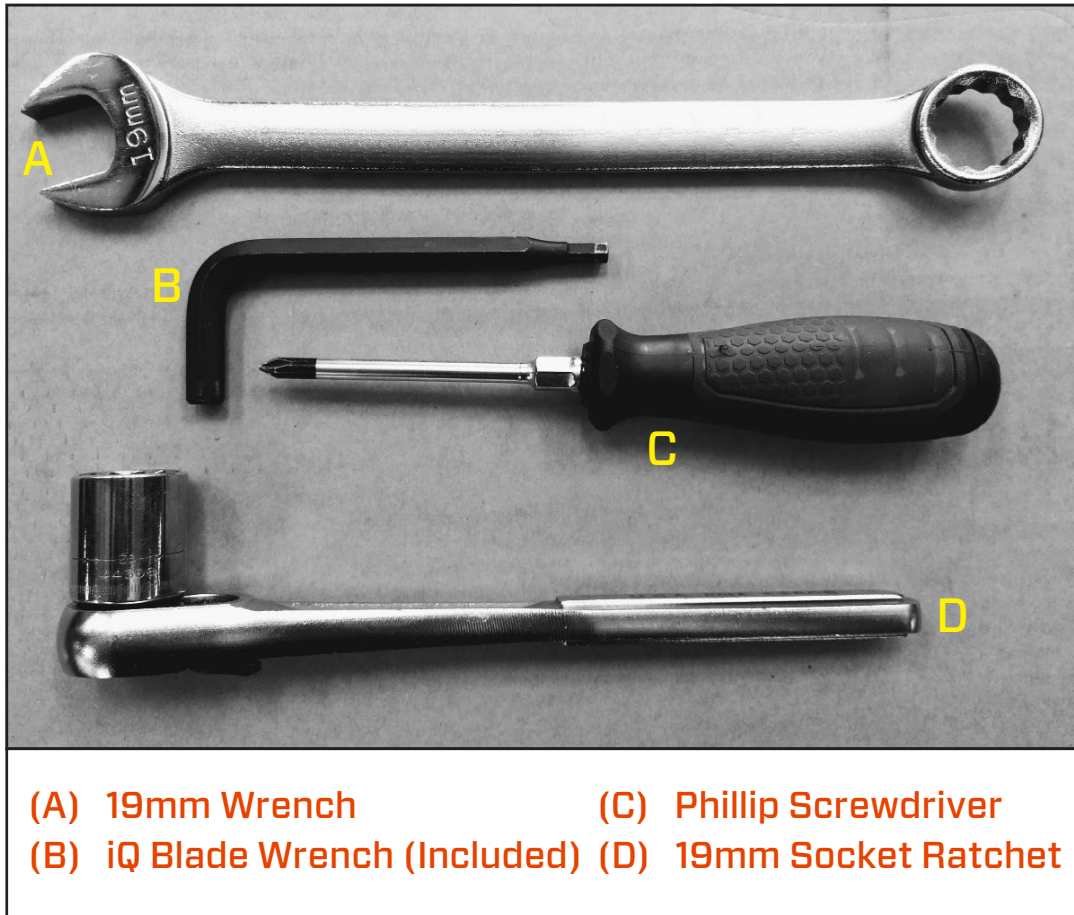

ASSEMBLING

Assembling your iQMS362™

UNBOXING AND ASSEMBLING

Open the top of the box. Remove top layer of foam with parts and set aside. Remove main frame assembly and place on a flat horizontal and stable surface (preferably a workbench) to prevent the equipment from tipping or sliding during assembly.



IMPORTANT ASSEMBLY STEP
REMOVE SCREW AND SHIFT HOLE TO LINE UP WITH V-GROOVE AND INSTALL (4) FRAME MOUNTING SCREWS (2 ON EACH SIDE)

MOUNTING THE X-STAND

Remove screw from frame (A) on each side.

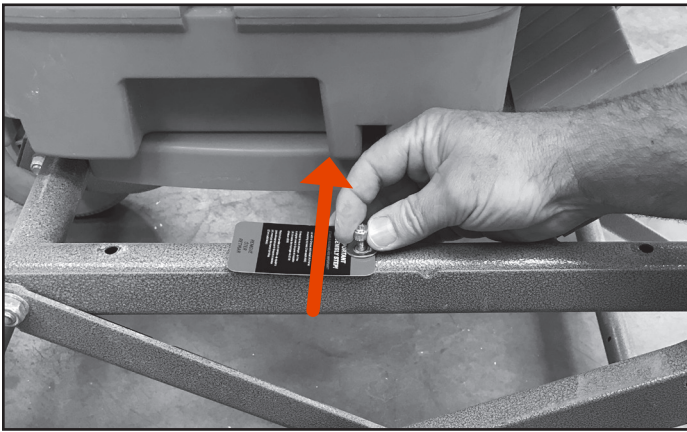

Position frame tube to align with V-Notch. Install (4) mounting screws, (2) on each side.

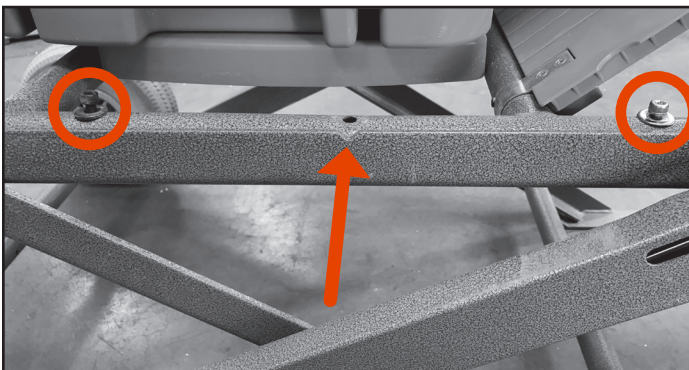

Rotate spring hook end to engage linkage rod.

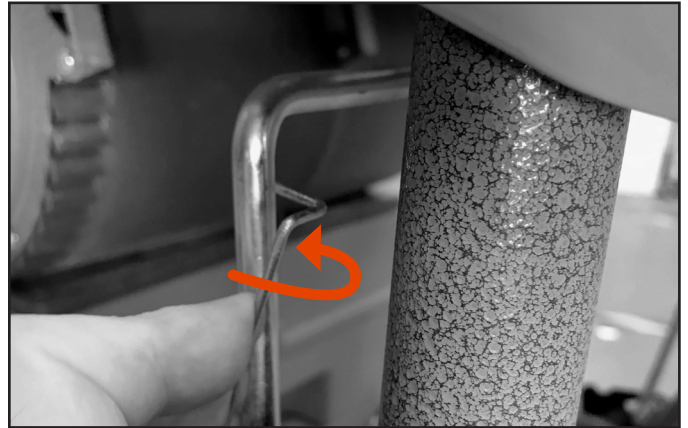

Insert linkage rod into X-Stand latch/lock slot on each side.



INSTALLING THE WHEELS

Insert 1/2 inch bolt into wheel, then insert into wheel mount hole.

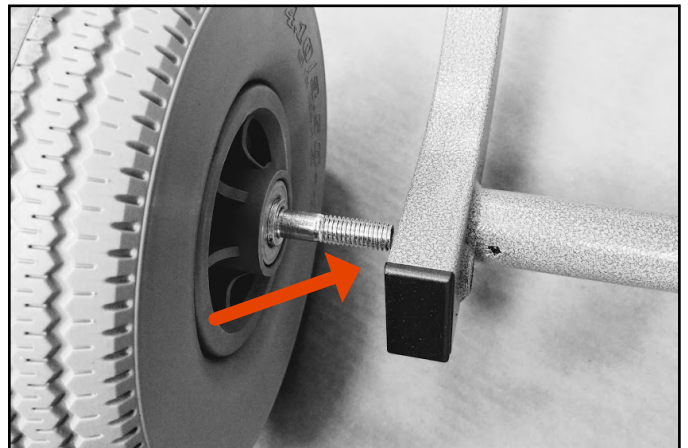

ASSEMBLING

Install 1/2 inch nut onto bolt and tighten.

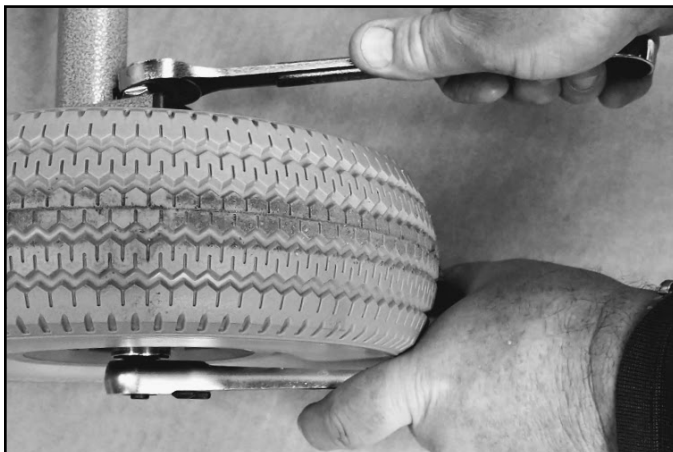

Securely tighten the (4) Allen screws with supplied Allen wrench.



MOUNTING THE SUPPORT ARM

Remove the support arm/saw motor head from box and packaging. Install the support arm onto the left rear support arm mounting surface by lining up the pins.

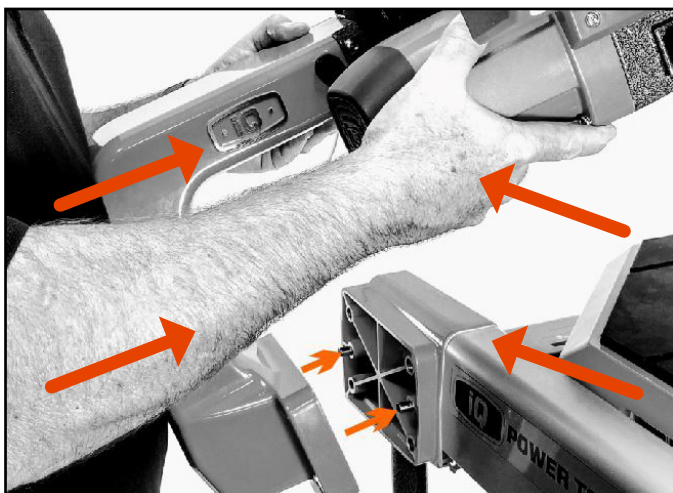

Install the (4) Allen screws. Tighten all 4 screws finger tight.

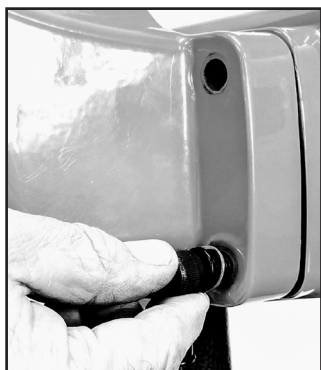

ATTACH DUST GUARD VACUUM HOSE

Slip lower vacuum hose onto cyclone inlet.

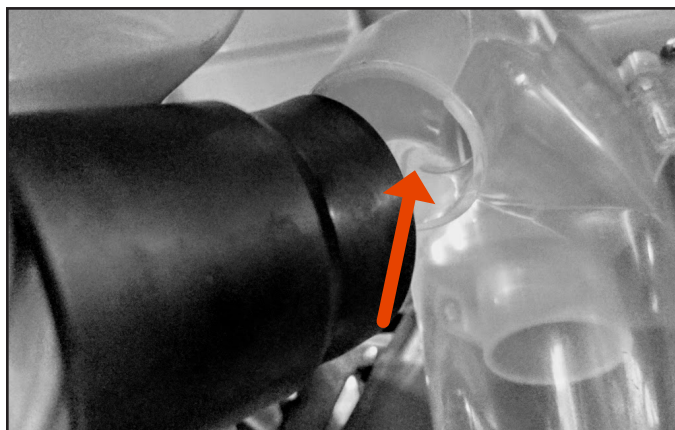

Slip upper vacuum hose onto dust guard inlet.

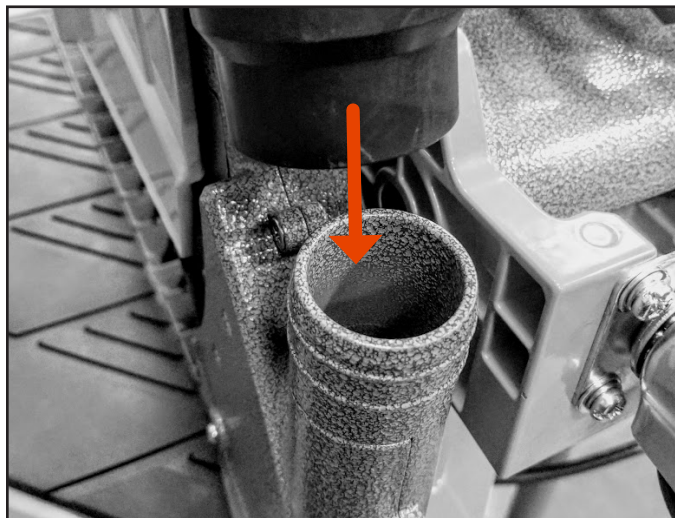

ASSEMBLING

CONNECTING THE VACUUM MOTOR POWER

The vacuum power supply cable from the support arm needs to be routed through the cable retainer.

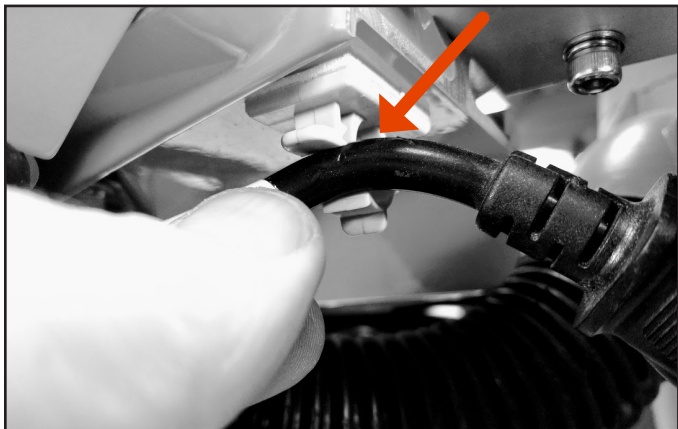

Snap the cable retainer closed securing the cable.



Plug the vacuum power cable into the vacuum power supply receptacle.

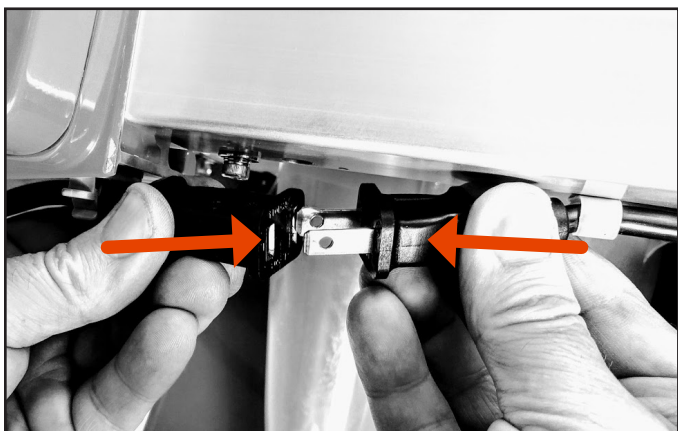

INSTALL TRANSPORT HANDLE

Insert transport handle with holes down into a front cross frame as shown.

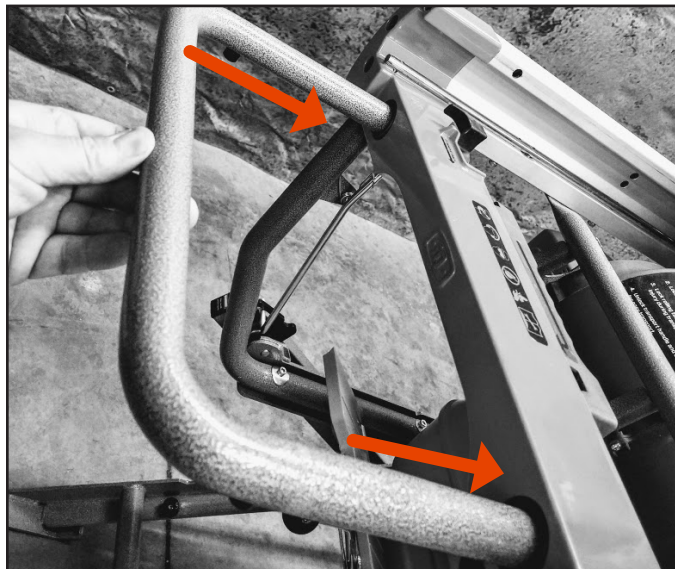

Insert lock screws into handle and tighten.

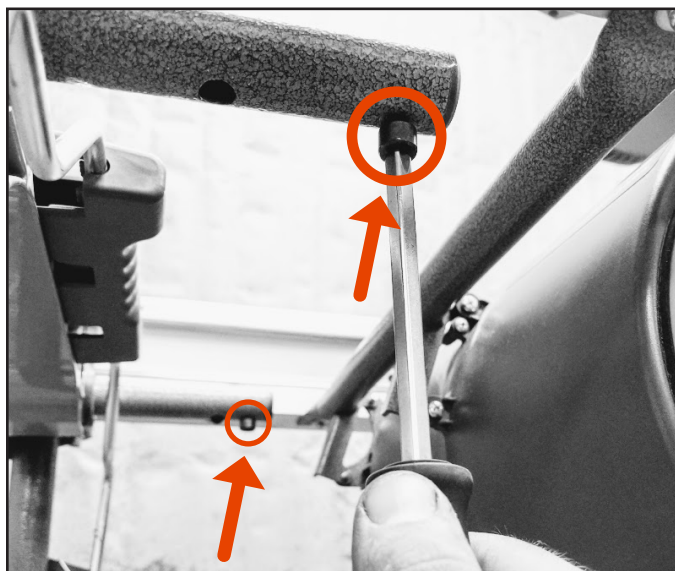

ASSEMBLING

ASSEMBLING THE TABLE EXTENSION

Remove the table extension from packaging. Insert the extension shafts into the right side of rolling table.

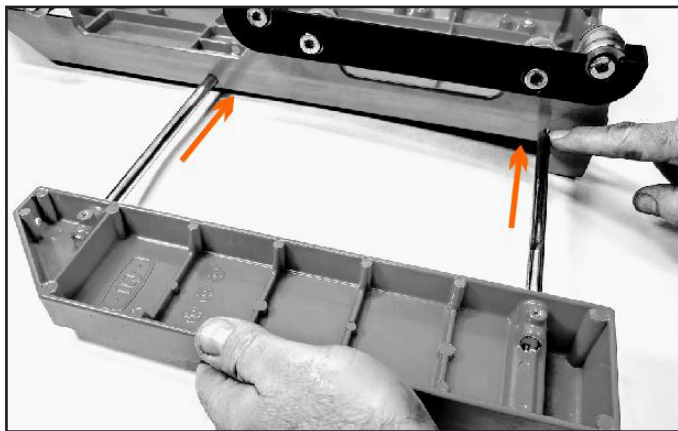

With a Phillips screwdriver, install screws in each end of extension shaft to secure.

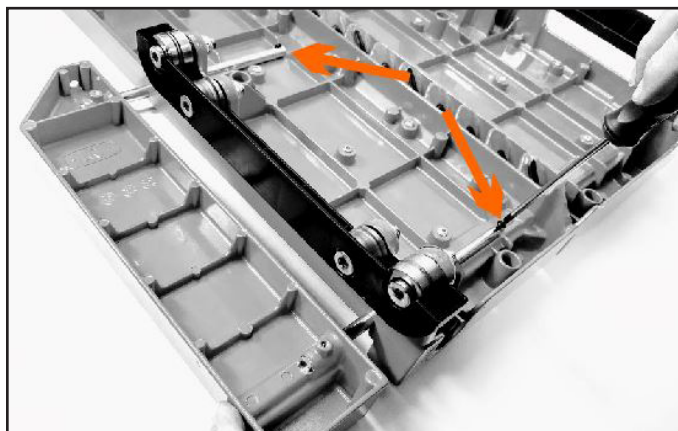

INSTALLING THE ROLLING TABLE

Put the Remove Table Lock lever in the down position. This allows the rolling table to be installed or removed.



⚠ WARNING!

POSITION INADVERTENTLY THIS COULD CAUSE DAMAGE AND/OR INJURY

IF THE REMOVE TABLE LOCK LEVER IS LEFT IN THE DOWN POSITION

Holding the table in front of you, on the left side of the table line is the 1st notch wheel roller with the guide rail. Push the table along the guide rail until the 2nd and 3rd notch wheel rollers are on the guide rail.

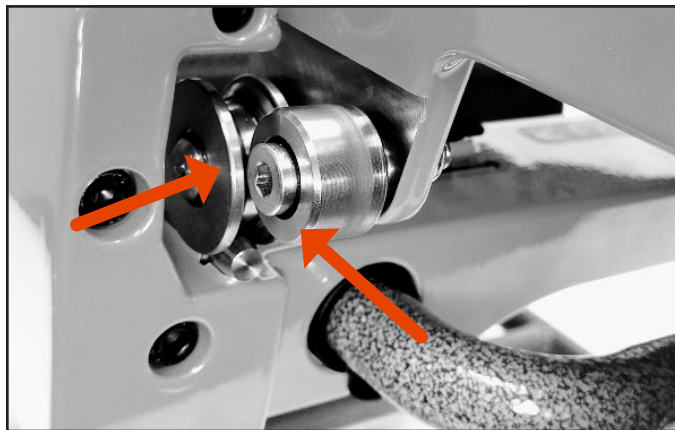

Put the remove table lock lever in the up position. The remove table lock lever should remain in the up position for normal operation. The remove table lock lever should only be put in the down position for table removal and maintenance.



BLADES

General

⚠ WARNING! BLADES CAN BREAK AND CAUSE SERIOUS INJURIES TO THE USER. DIAMOND BLADES CAN BECOME VERY HOT WHEN NOT USED PROPERLY. AN OVERHEATED BLADE MAY CAUSE DEFORMATION OF THE BLADE, RESULTING IN DAMAGE AND INJURIES.

The iQMS362™ dry cutting masonry saw utilizes a specially designed diamond blade with a Q-Drive Arbor hole. The 16.5" Q-Drive dry cutting blade uses a proprietary composition of diamond concentration and metal type to make a blade that cuts cool while reducing vibration and movement. The specially designed blade works in conjunction with the vacuum flow to keep the blade and the material cool while cutting.

The iQMS362 16.5" dry cutting blades with Q-Drive Arbor hole can be purchased from your local iQ Power Tools dealer or directly from iQ Power Tools by calling 888-274-7744, or through our website at www.iQpowertools.com

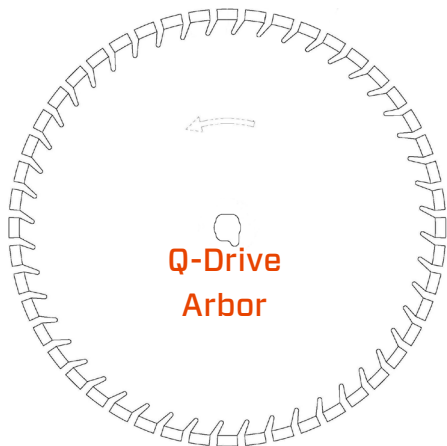

The Q-Drive Arbor hole shape also fits a standard 1" round blade shaft for versatility.

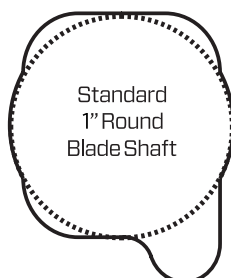

Blades for Different Materials

⚠ WARNING! NEVER USE A BLADE FOR ANY OTHER MATERIAL THAN THAT IT WAS INTENDED FOR. CUTTING PLASTICS WITH A DIAMOND BLADE CAN CAUSE KICKBACK WHEN THE MATERIAL MELTS DUE TO THE HEAT PRODUCED WHEN CUTTING AND STICKING TO THE BLADE. NEVER CUT PLASTIC MATERIALS WITH A DIAMOND BLADE!

The iQMS362™ dry cutting masonry saw is supplied with specially designed 16.5" Dry Cutting Combination Blade with Q-Drive Arbor hole that is engineered to cut masonry, concrete and stone products.

Blade selection should be made according to the material being cut. Ask your local dealer for help in choosing the right product.

BLADE VIBRATIONS

- The blade can become out of round and vibrate if too high of a feed pressure is used.
- A lower feed pressure can stop the vibration. Otherwise replace the blade.

SHARPENING DIAMOND BLADES

- Always use a sharp diamond blade.
- Diamond blades can become dull when the wrong feeding pressure is used or when cutting certain materials such as very hard material. Working with a dull diamond blade causes overheating, which can result in the diamond segments coming loose.
- Sharpen the blade by using a dressing stone or by cutting in a soft material such as sandstone or soft brick.

TRANSPORT AND STORAGE

- Remove the blade before transportation or storage of the machine.
- Store the blade in a dry place.
- Inspect new blades for transport or storage damage.

BLADES

INSTALLING THE BLADE

While pushing down on the cutting head handle, pull out on the lock down knob. Allow the cutting head to move to the full up position.

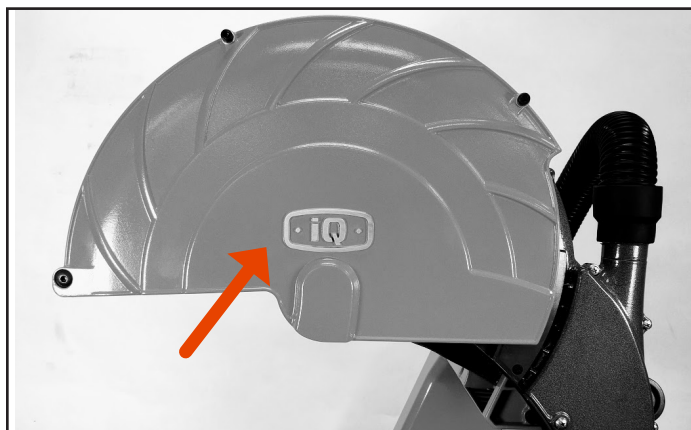

Open outside blade guard by tilting, exposing blade shaft nut and flange washer.

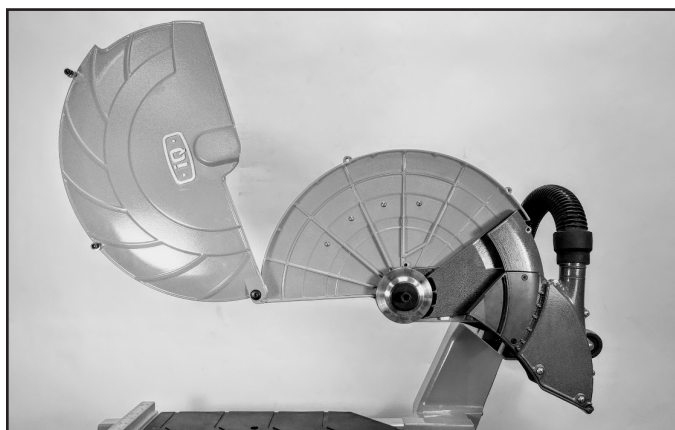

Use blade wrench.



Loosen the blade guard screw 1 and 2.

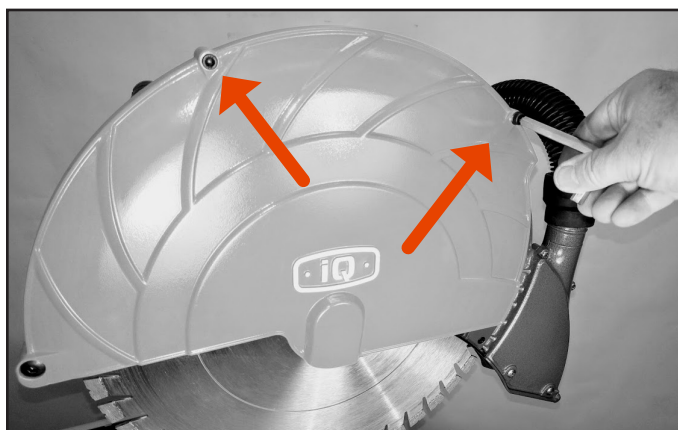

Remove the blade shaft nut and outside flange washers.



Note the Q-Drive shaped blade shaft. The IQMS362™ must be used with the specially designed 16.5" dry cutting blade with Q-Drive Arbor hole.

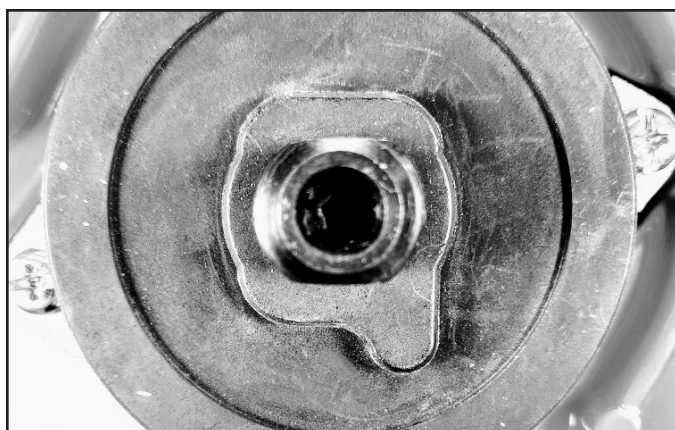

The Q-Drive Arbor hole shape without bushing also fits a standard 1 inch round blade shaft for versatility.

BLADES

Insert blade into dust guard and line up Q arbor hole.

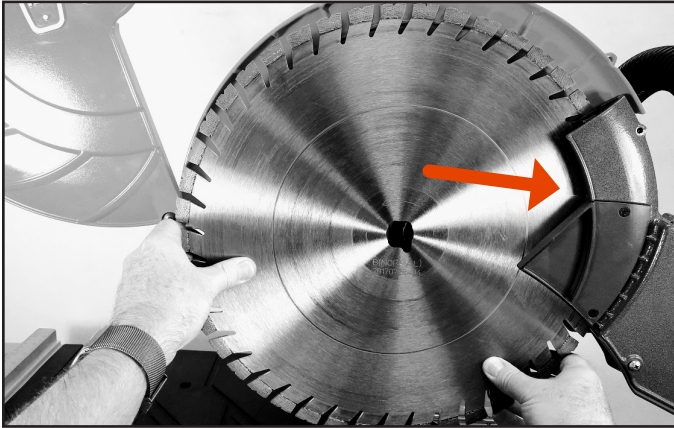

Tighten blade screw.



Press blade lock.



Secure guard.



OPERATING

Before starting

⚠ WARNING! PLEASE READ THE OPERATOR'S MANUAL CAREFULLY AND MAKE SURE YOU UNDERSTAND THE INSTRUCTIONS BEFORE USING THE MACHINE

Wear personal protective equipment. See instructions under the heading "Personal Protective Equipment". Make sure no unauthorized persons are in the working area, otherwise there is a risk of serious personal injury. Prevent unintentional starting of the motor. Ensure the power switch is in the OFF position before connecting the machine to a power source.

Check that the machine is assembled correctly and do not show any signs of damage. See instructions in the section "Assembling and Adjustments".

- Perform daily maintenance. See instructions in the section "Maintenance".

STARTING MACHINE

The saw power switch starts the saw motor and vacuum motor simultaneously. To start the saw motor, engage the **POWER** switch - or on symbol. Defective switches should be replaced by an authorized service workshop.

STOPPING MACHINE

To stop the saw motor engage the **POWER** switch **O** or off symbol.

⚠ WARNING! MAKE SURE CUTTING BLADE COMES TO A COMPLETE STOP BEFORE PERFORMING ANY MAINTENANCE OR TRANSPORTING.

Basic working techniques

MAKING THE FIRST CUT

While making the first cut, you will notice the blade is cutting into the plastic louvers. This is normal and part of their design.

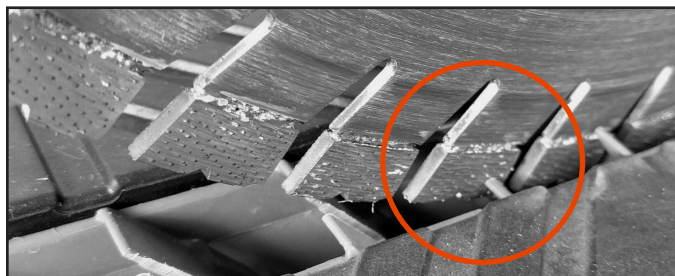

TYPICAL CUTTING OPERATION

The cutting head should be left in the lock down position for typical tile cutting.

⚠ WARNING! OPERATING THE MACHINE IN SITUATIONS WHERE DUST COLLECTION IS LIMITED FOR PROLONGED PERIODS CAN CREATE DUSTY AND POTENTIALLY HAZARDOUS WORK ENVIRONMENT FOR THE OPERATOR AND OTHER PERSONS IN THE VICINITY.

CHOP CUTTING

When cutting oversized material, it is recommended that the operator keep the blade as low as possible to direct dust into the louvers.

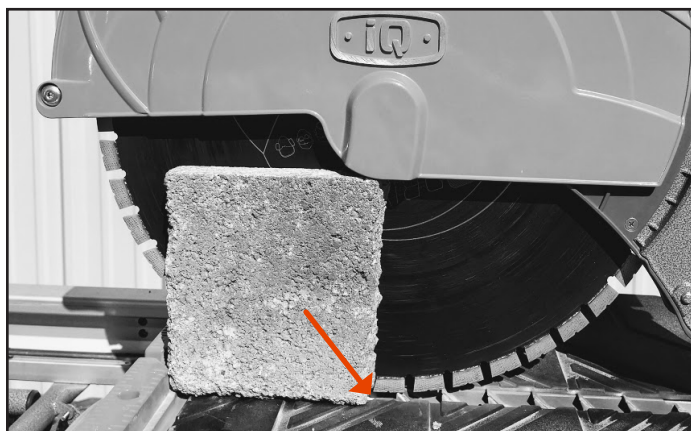

OPERATING

Maintenance

⚠ WARNING! PLEASE READ THE OPERATOR'S MANUAL CAREFULLY AND MAKE SURE YOU UNDERSTAND THE INSTRUCTIONS BEFORE USING THE MACHINE

GENERAL

To prevent accidental starting, the steps described in this chapter must be performed with the motor off and the power cable removed from the socket, if not otherwise stated.

Wear personal protective equipment. See instructions under the heading "Personal Protective Equipment". The life span of the machine can be reduced and the risk of accidents can increase if machine maintenance is not carried out correctly and if service and/or repairs are not carried out professionally. If you need further information, please contact your nearest servicing dealer.

DAILY MAINTENANCE

- Check that the machine's safety equipment is undamaged. See instructions in the section "Machine's safety equipment".
- Clean the outside of the machine. Do not use a high pressure washer to clean the saw.
- Open the blade guard. Clean both the inside and outside, and close the blade guard.

⚠ WARNING! NEVER CLEAN MOTOR AND ELECTRIC PARTS WITH WATER.

⚠ NOTICE! KEEP THE ROLLING TABLE SURFACE FREE OF CHIPS AND LARGE DEBRIS.

⚠ NOTICE! KEEP THE DUST COLLECTION LOUVERS AND TOP SLOT FREE OF CHIPS AND LARGE DEBRIS.

⚠ CAUTION FAILURE TO KEEP THE DUST COLLECTION LOUVERS AND TOP SLOT FREE OF CHIPS AND LARGE DEBRIS COULD RESULT IN THE ROLLING TABLE JAMMING AGAINST THE TOP SLOT AND CAUSING DAMAGE TO THE MACHINE.

⚠ WARNING! MISHANDLING OF THIS PRODUCT COULD VOID WARRANTY.

VACUUM AND FILTER MAINTENANCE

FILTER SYSTEM

Filter system of the IQMS362 is designed to function automatically with the masonry saw. The vacuum motor automatically starts with the saw motor start. The system is designed to operate for 150 linear feet of cutting before cleaning filter or emptying dust tray.

DUST COLLECTION VACUUM OPERATION



1. Spin filter every 30 minutes of cutting or at the end of each day. Spin filter before emptying dust collection tray.
2. Empty dust collection tray after approx. 150 L.F of cutting or at the end of each day before transport.
3. Empty dust into bag or sealed container and dispose properly.



Slide dust tray out.

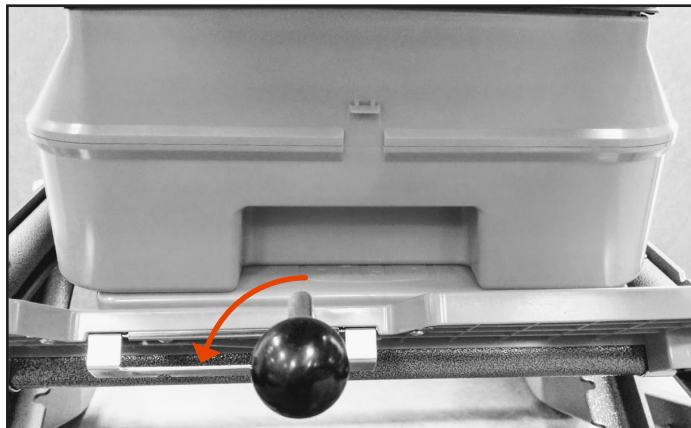

Empty dust into bag or sealed container and dispose properly. Empty dust collection tray after 150 L.F. of cutting or at the end of each day before transport.

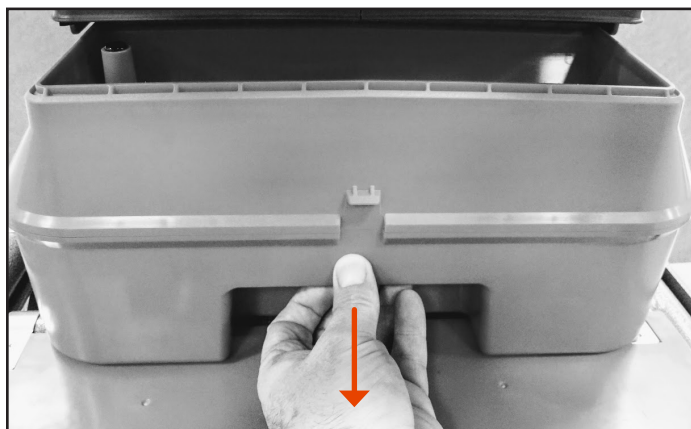

CLEANING THE FILTER AND EMPTYING DUST TRAY

Spin filter three times every 30 minutes of cutting or at the end of each day. Spin filter before emptying dust collection tray. Rotate dust tray release lever to the left.



VACUUM AND FILTER MAINTENANCE

⚠ WARNING! MAKE SURE CUTTING BLADE COMES TO A COMPLETE STOP BEFORE PERFORMING ANY MAINTENANCE OR TRANSPORTING.

CHANGING THE FILTER AND FILTER CLEANING TAB

Filter and cleaning tab should be changed once each year regardless of use.

Remove the filter spin knob.



Loosen screws and remove filter cover.



Remove filter.



⚠ WARNING! WHILE DOING MAINTENANCE ON THIS MACHINE THERE IS A POTENTIAL EXPOSURE TO DUST WHICH MAY CONTAIN HAZARDOUS MATERIAL. PROTECT YOURSELF BY WEARING AN APPROPRIATE BREATHING MASK.

Remove and replace filter cleaning tab. While pushing down on retainer (A) slide filter cleaning tab out (B) of filter cleaning tab bracket.

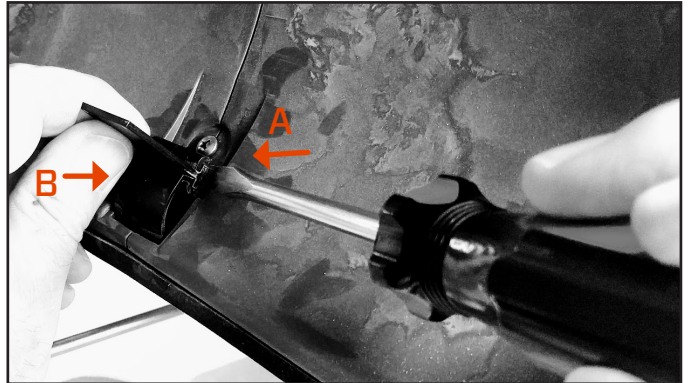

Slide new filter cleaning tab into filter cleaning tab bracket.

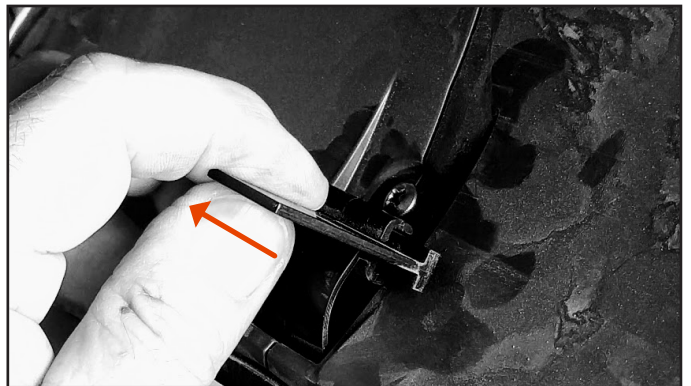

Install new filter into filter housing. Rotate filter slightly as it is inserted over filter spindle. Install filter cover and screws. Install filter spin knob.



VACUUM AND FILTER MAINTENANCE

⚠ WARNING! MAKE SURE CUTTING BLADE COMES TO A COMPLETE STOP BEFORE PERFORMING ANY MAINTENANCE OR TRANSPORTING.

REPLACING CARBON BRUSHES

The carbon brushes must be removed and checked regularly. Weekly if the machine is used daily. These instructions apply to the saw motor and the vacuum motor. The two carbon brushes (A) and (B) are located on the front and back side of the motor. Loosen carbon brush retainer cap with standard screwdriver.

Inspect carbon brush and replaced it necessary.



Remove carbon brush retainer cap.

Install carbon brush making sure to align tabs into slots.



Remove carbon brush.

Tighten carbon brush retainer cap to secure.

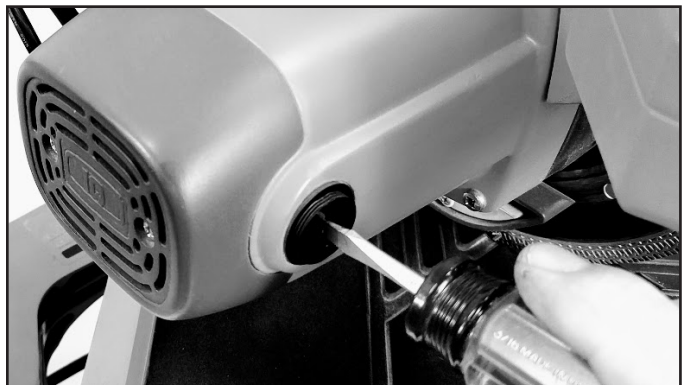

CHANGING THE LOUVERS

Periodically the plastic louvers will need to be changed. The plastic louvers are made up of three sections. The two front pieces are the same while the rear piece is different.

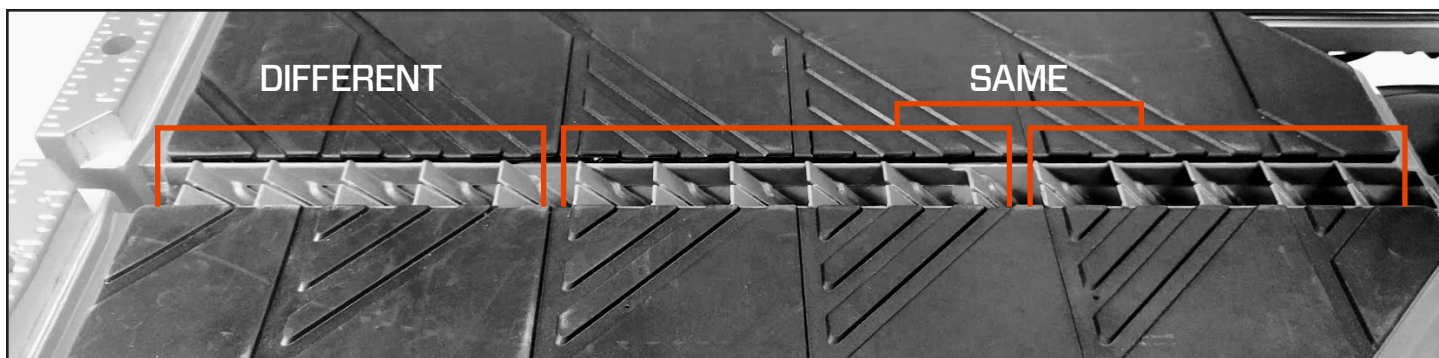

REMOVING THE LOUVERS

To change the louvers, remove the table and set it on a secure surface with the wheels up. Each section of plastic louver has a loop retainer that slips over a tab on the table louvers. With light pressure lift up plastic loop and push down to release. Repeat this process at each end of each louver.

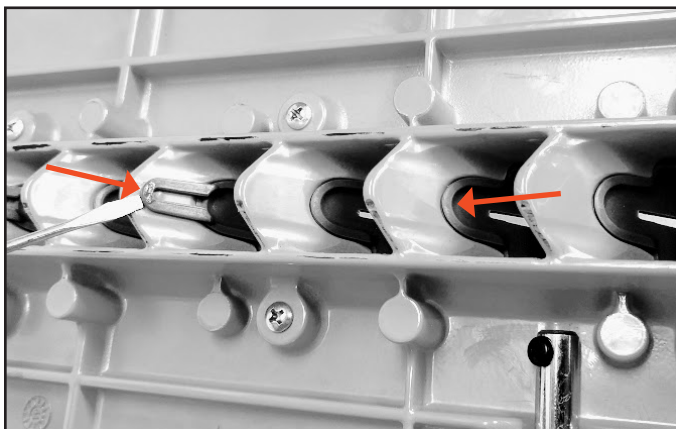

REPLACING THE LOUVERS

Start with the back plastic louver. With the table right side up, line the plastic louvers up with table louvers, push down at 45° and snap into place.

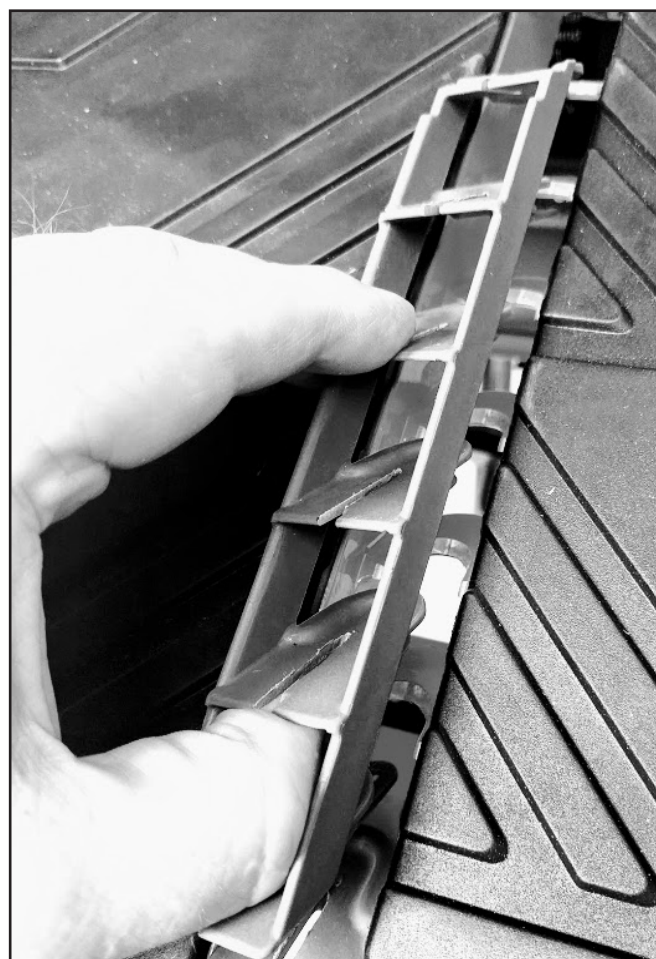

ADJUSTMENTS

ADJUSTING THE TOP SLOT

Note: The top slot adjustments are set at the factory so adjustment will only need to be performed after extended use or after parts replacement.

⚠ NOTICE! PROPER GAP BETWEEN THE TOP SLOT IN ROLLING TABLE LOUVERS IS CRITICAL TO MAINTAIN VACUUM AND GOOD DUST COLLECTION.

The gap between the top slot and rolling table louvers should be set at 1/32" or less (A). The top slot and rolling table louvers should not be touching or rubbing during table motion. If they are rubbing, an adjustment is necessary.

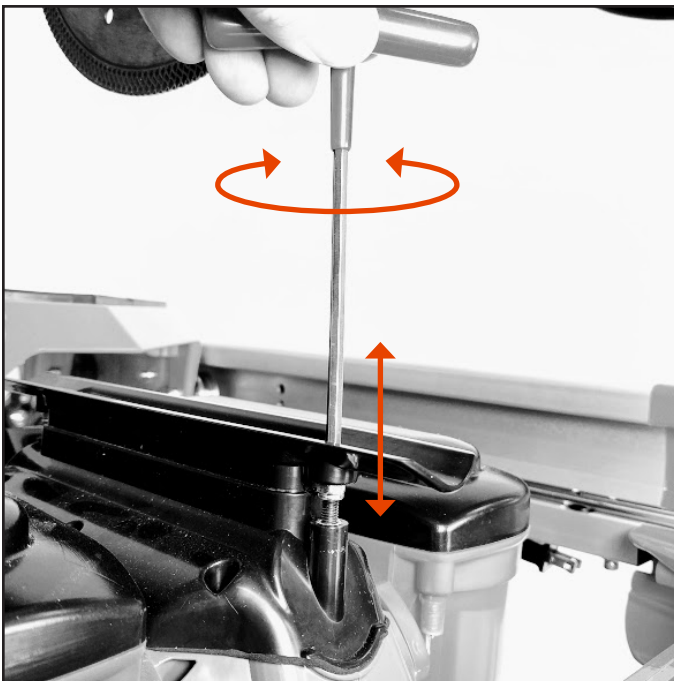
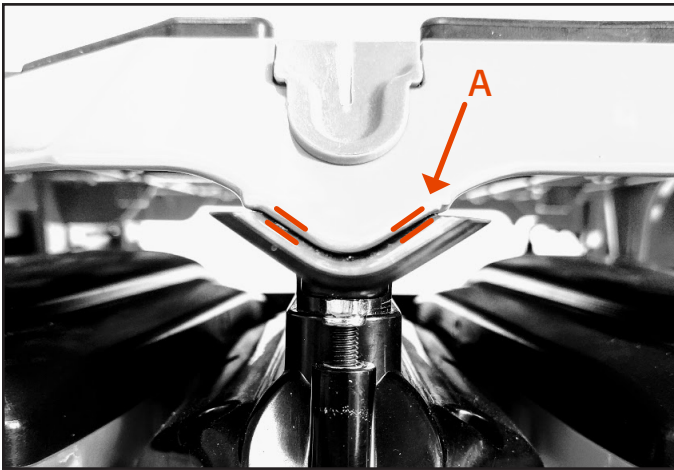

ADJUSTING THE ROLLING TABLE UPPER ROLLER

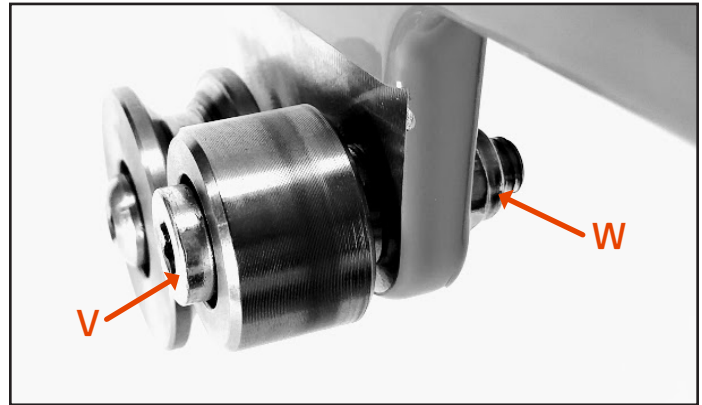

1. With Allen wrench secure axle cam screw (V), loosen axle nut (W).
2. With Allen wrench turn axle cam screw till there is a slight resistance when rotating upper roller by hand.
3. While holding Allen wrench and axle cam screw in position tighten axle nut to secure.

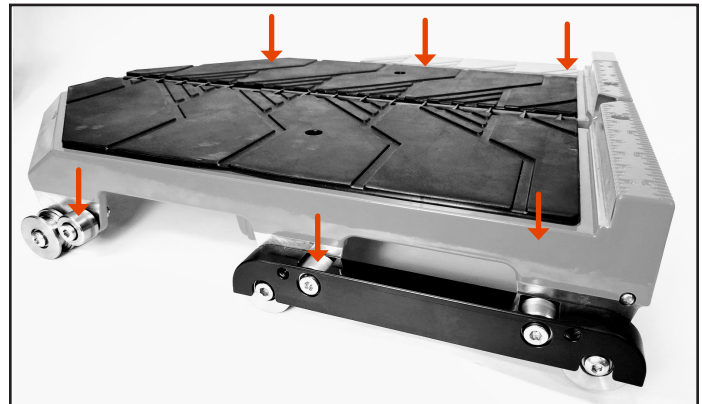

4. Follow the same procedure for all six upper rollers.

ADJUSTING AND SQUARING THE ROLLING TABLE

Note: The rolling table is set squared to the cutting head at the factory and is certified to be within an industry-leading standard of 0.015" or 1/64".

Adjustment will only need to be performed after extended use or after parts replacement.

ADJUSTMENTS

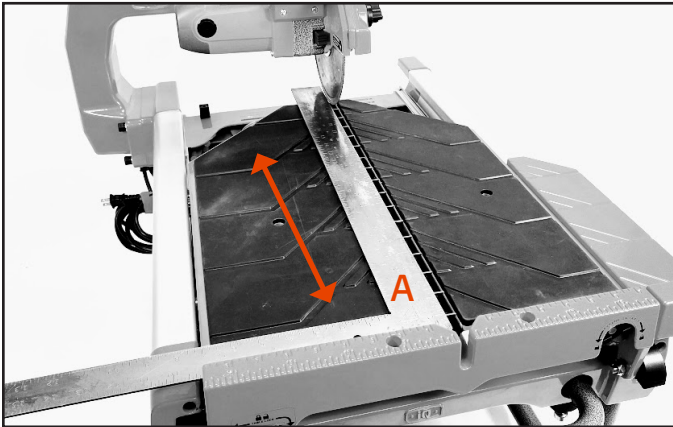

Lay a 90° Square flat on the rolling table surface with one side against the cutting fence (A).

Move the rolling table through the full motion front to back. If the blade is not 90° to the cutting fence guide rail will need adjustment.

Loosen the six rail mounting screws (X).
(Access screws from underneath left side rail.)

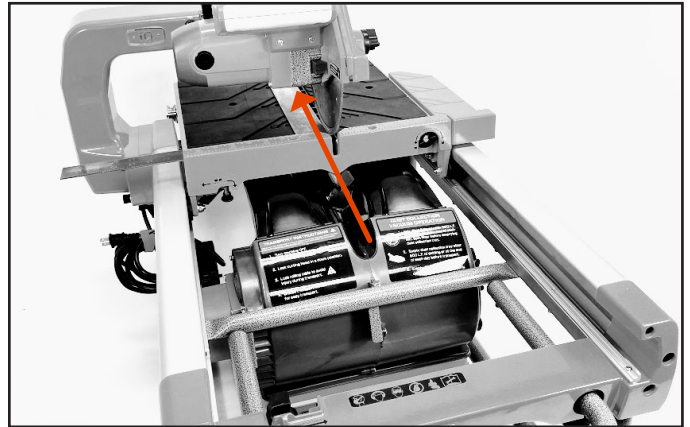

VERSION 1 - WITH ADJUSTER CAM

Position the guide rail adjuster cam screws (Y) until the blade is squared to the cutting fence (A) through the full motion of the rolling table front to back. When the guide rail is in correct position tighten the six rail mounting screws (X).

VERSION 2 - WITHOUT ADJUSTER CAM

Adjust Rolling Table position until blade is squared to the cutting fence (A) through the full motion of rolling the table front and back.

OUTSIDE VIEW

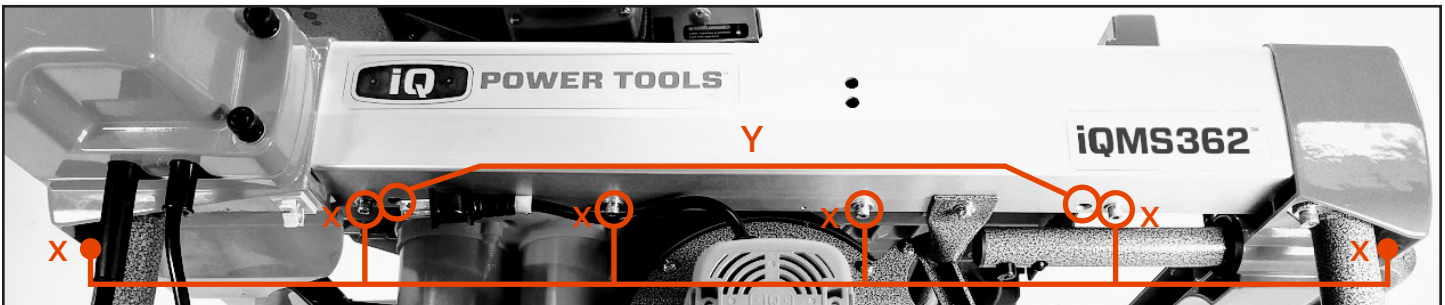

INSIDE VIEW

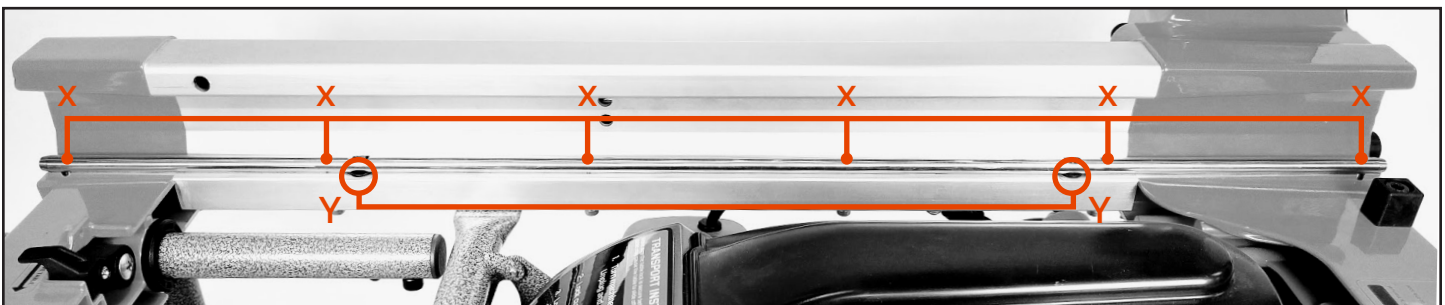

X-STAND

TO RAISE X-STAND

To release X-Stand, slide handle right and pull in.

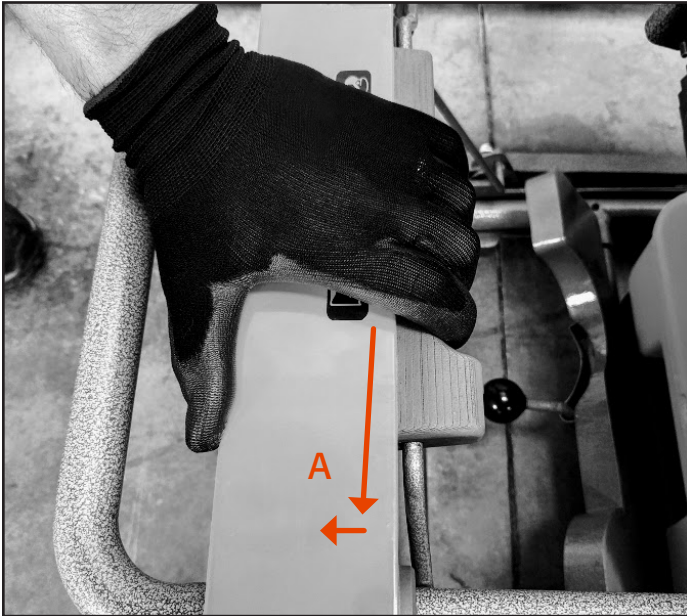

To raise X-Stand, step down on lever (A), press X-Stand release trigger and lift. **Keep handle pressed** until in full raised position.

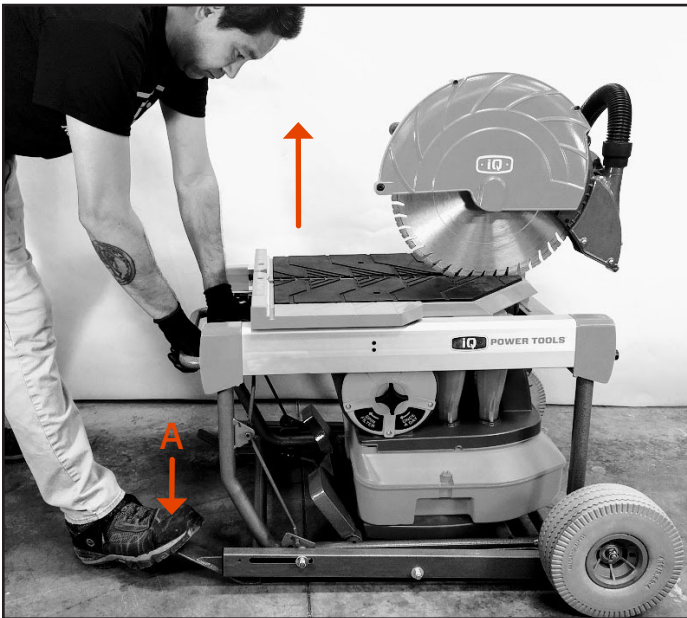

TO LOWER X-STAND

To release X-Stand, slide handle right and pull in.

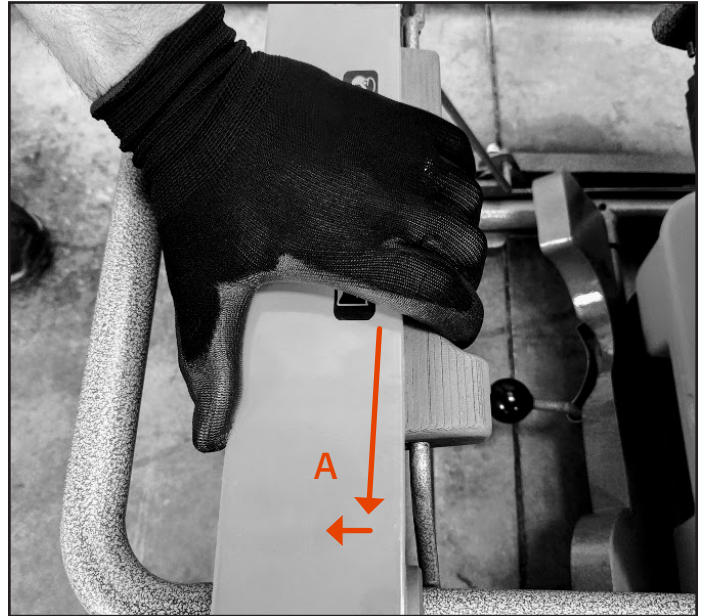

To lower X-Stand, press X-Stand release trigger and push down. Ease X-Stand down till latches lock. **Keep handle pressed** until in full raised position.



⚠ WARNING!

THERE IS ALWAYS A RISK OF CRUSH INJURIES WHEN WORKING WITH PRODUCTS CONTAINING MOVING PARTS. WEAR PROTECTIVE GLOVES TO AVOID BODY INJURIES.

⚠ WARNING!



THERE IS ALWAYS A RISK OF PINCH INJURIES WHEN WORKING WITH PRODUCTS CONTAINING MOVING PARTS.

TRANSPORTING

⚠ CAUTION! THE LOCK CATCH MUST CLICK IN PLACE WHEN IN THE LOCKED UP POSITION & LOCKED DOWN POSITION.

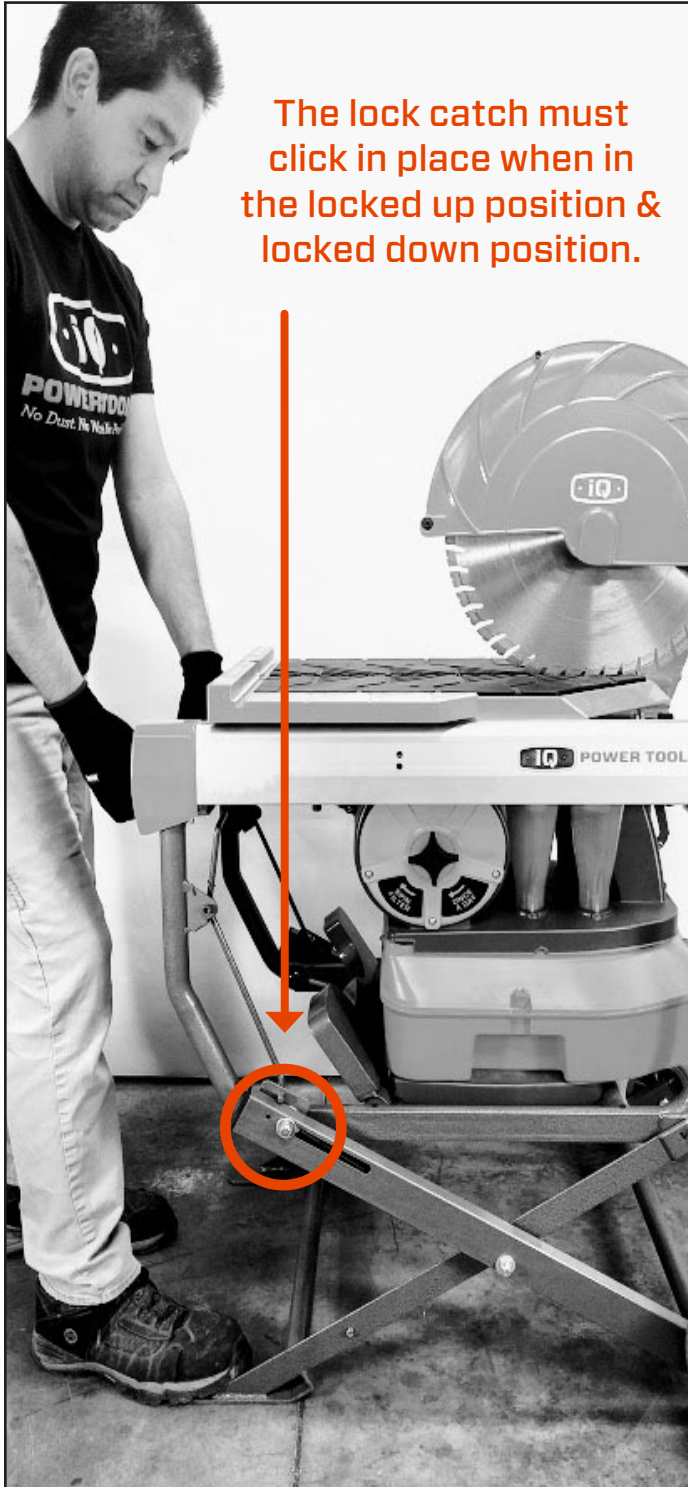

The lock catch must click in place when in the locked up position & locked down position.

Transportation

TRANSPORT INSTRUCTIONS

Make sure the table lock is secure before transporting saw. Failure to lock table may cause the table to slide off the saw and cause serious injury.

1. Turn machine OFF. Unplug and secure power cord.
2. Lock cutting head in a down position.
3. Lock rolling table to avoid injury during transport. ⚠
4. Unlock transport handle and extend for easy transport.

GENERAL

Stop the motor and disconnect the power cable before lifting or moving the machine.

- Secure the equipment during transportation in order to avoid transport damage and accidents.
- Ensure that the rolling table is locked and that the extension table is locked in its inner position.
- Store the equipment in a lockable area so that it is out of reach of children and unauthorized persons.
- For transport and storage of Blades, see the section “Blades”.
- Lift the machine at the short ends.

⚠ WARNING! WARNING! BE SURE TO LOCK THE ROLLING TABLE BEFORE TRANSPORT TO AVOID EQUIPMENT DAMAGE OR PERSONAL INJURY.

TRANSPORTING

TRANSPORTING

To extend transport handle pull lock pin (A) and pull handle out.

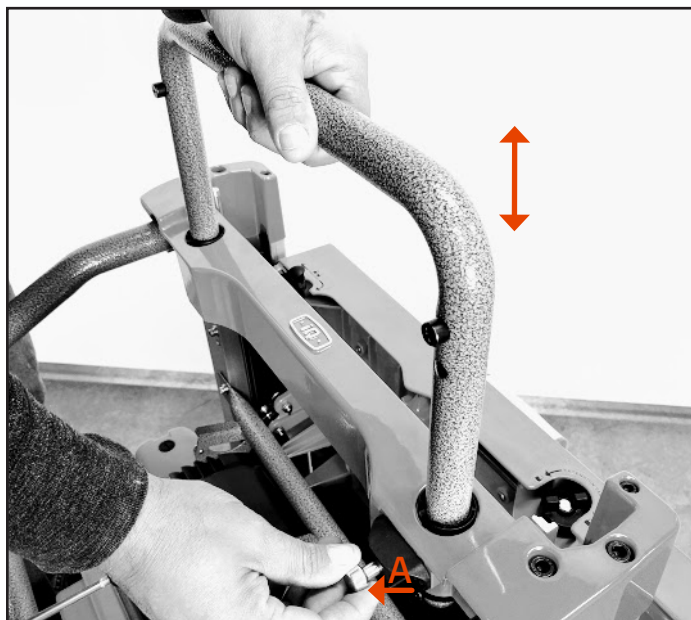

Machine can now be tipped forward onto the wheels for easy transport.



Storage

⚠ WARNING!

THE IQMS362 IS A PRECISION CUTTING TOOL. PROPER CARE DURING TRANSPORT AND STORAGE IS IMPORTANT TO MAINTAIN FACTORY SETTINGS AND CUTTING PERFORMANCE.

Recommended Storage Position:



Do not transport or store in vertical position.



Damage or misalignment could occur if transported or stored in vertical position.

⚠ WARNING!

MISHANDLING OF THIS PRODUCT COULD VOID WARRANTY.

TROUBLESHOOTING GUIDE

BE SURE TO FOLLOW SAFETY RULES AND INSTRUCTIONS.
MANY COMMON PROBLEMS CAN BE SOLVED EASILY BY UTILIZING THE CHART BELOW.
FOR MORE SERIOUS OR PERSISTENT PROBLEMS, CONTACT IQ POWER TOOLS AT 1-(888)274-7744.

TROUBLE! SAW WILL NOT START

WHAT'S WRONG?	WHAT TO DO
1. Saw not plugged in	1. Plug in saw
2. Cord is damaged	2. Have cord replaced by authorized service center
3. Brushes worn out	3. Have brushes replaced by authorized service center

TROUBLE! SAW MAKES UNSATISFACTORY CUTS

WHAT'S WRONG?	WHAT TO DO
1. Dull cutting blade	1. Replace cutting blade
2. Blade not cutting	2. Use dressing stone
3. Build up on cutting wheel	3. Use dressing stone to remove build up
4. Incorrect cutting wheel for work being done	4. Change the cutting wheel

TROUBLE! CUTTING WHEEL DOES NOT COME UP TO SPEED

WHAT'S WRONG?	WHAT TO DO
1. Extension cord too small of a wire gauge or too long	1. Replace with adequate size cord
2. Low house voltage	2. Contact your electric company

TROUBLE! MACHINE VIBRATES EXCESSIVELY

WHAT'S WRONG?	WHAT TO DO
1. Stand or bench on uneven floor	1. Reposition on flat level surface
2. Damaged saw cutting wheel	2. Replace cutting wheel

TROUBLE! DOES NOT MAKE ACCURATE CUTS

WHAT'S WRONG?	WHAT TO DO
1. Cutting guide not secure to fence	1. Check and adjust
2. Cutting wheel is not square to fence	2. Check and adjust
3. Cutting wheel is not perpendicular to table surface	3. Check and adjust
4. Work piece moving	4. Use edge guide

TROUBLE! LOSS OF VACUUM SUCTION

WHAT'S WRONG?	WHAT TO DO
1. Vacuum motor not running	1. Check vacuum and motor plug
2. Filter plugged	2. Spin filter cleaning knob
3. Dust tray in unlocked position	3. Lock dust tray in up position
4. Dust tray over filled with dust	4. Empty dust tray and remove dust build up around filter and cyclones

TECHNICAL DATA

SAW MOTOR IQMS362, 120V

POWER, AMPS/WATTS	15 / 1800
VOLTAGE, V	120
PHASES	1
FREQUENCY, HZ	50 / 60
BLADE SPEED, RPM	3700

VACUUM MOTOR

POWER, AMPS/WATTS	5 / 600
FREQUENCY, HZ	60
VOLTAGE	120
CFM / dm ³ /5	100

CUTTING EQUIPMENT

BLADE SIZE - MAX, INCH/MM	16.5 / 420
SAW DEPTH - MAX, INCH/MM	5.5 / 140
CUTTING DEPTH AT 45° - MAX, INCH/MM	2.5 / 63
CUTTING LENGTH - MAX, INCH/MM	24 / 610
ARBOR CONFIGURATION	Q-DRIVE

DIMENSIONS

WEIGHT (LB/KG)	150 / 68
SHIPPING WEIGHT (LB/KG)	165 / 75
SIZE (l x w x h), INCH/MM	43 x 32 x 40 / 1092 x 813 x 1016
SHIPPING DIMENSIONS (l x w x h), INCH/MM	48 x 24 x 30 / 1219 x 609 x 762

ELECTRICAL

25FT	50FT	100FT	150FT
AWG	AWG	AWG	AWG
12	10	NOT RECOMMENDED	NOT RECOMMENDED
VOLTS 120v	VOLTS 120v	VOLTS 120v	VOLTS 120v

WIRING DIAGRAM

120VAc 52362

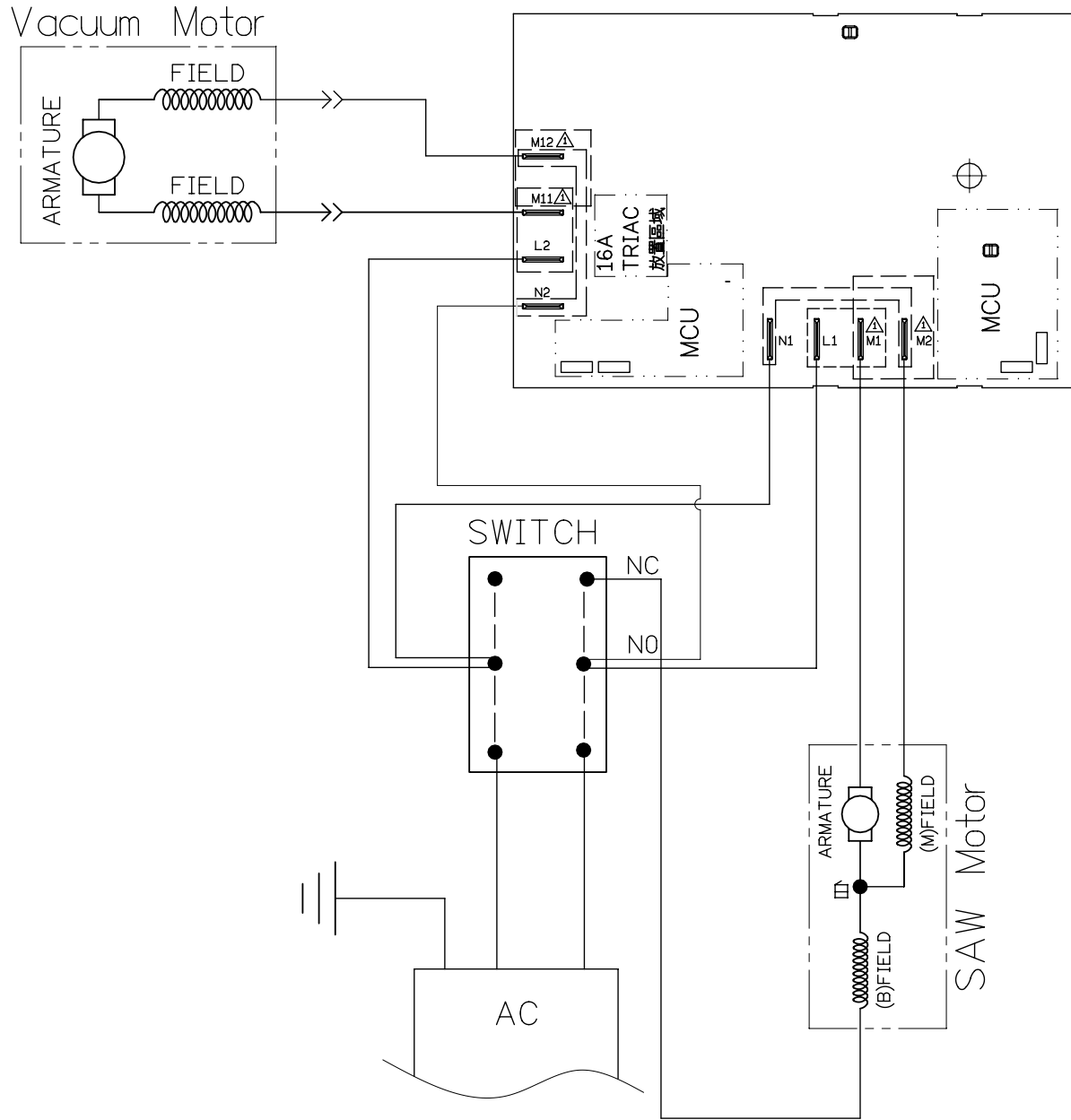

WARRANTY

New iQMS362™ Dry Cut Tile Saw, sold by iQ Power Tools or an iQ authorized dealer is warranted to be free from manufacturing defects in normal service for a one year period from date of purchase by the original consumer purchaser. Warranty period for rental items is 90 days.

All iQ products must be registered either through our website or by mailing in the Warranty Card in order for the warranty to be active and valid. This Warranty shall not apply to any parts that have been subjected to misuse or improper service, damaged in transit or handling, altered or repaired by unauthorized representatives, or used with a blade that is not recommended by iQ Power Tools.

Any claim arising under this Warranty must be submitted by the original purchaser within the Warranty period specified above and must include proof of purchase. Within Warranty period, options are either to replace or repair any parts or components that are found to be defective by iQ Power Tools at no charge to the original purchaser. iQ Power Tools shall not be responsible or obligated to pay for freight or other transportation-related costs or expenses in connection with any defective products, replacements, or components that are returned to iQ Power Tools facility or any authorized repair station.

Parts and labor needed to maintain products, and the replacement of components due to normal wear and tear, are the purchaser's responsibility and are not covered by this Warranty. All products or components replaced under Warranty become the property of the manufacturer. All replacement parts will be considered to be part of the original product and any Warranty on such parts will expire concurrently with this original Warranty.

iQ Power Tools will pay for parts and labor in connection with Warranty repairs conducted by iQ Power Tools or its authorized repair center. Replacement parts installed by anyone else will be provided without a charge but this Warranty will not apply to labor charges in connection therewith.

IN NO EVENT SHALL ANY LIABILITY UNDER THIS WARRANTY EXCEED THE REPLACEMENT COST OF ANY DEFECTIVE PRODUCT OR COMPONENT THEREOF. iQ POWER TOOLS SHALL NOT BE LIABLE FOR ANY INCIDENTAL OR CONSEQUENTIAL DAMAGES OR FOR ANY OTHER DAMAGE OR LOSS NOT EXPRESSLY ASSUMED AS SET FORTH HEREIN.

The Warranty on the terms above is the only Warranty. This limited Warranty is expressly in lieu of all other Warranties, whether expressed or implied.



POWER TOOLS

888-274-7744 | WWW.IQPOWERTOOLS.COM